

Meeting Stile Perimeter Seals

IS7340si, IS7345si, IS7350si, IS7355si



These translucent polycarbonate astragal seals suit 10mm and 12mm thick frameless glass doors, incorporating high temperature semi-transparent silicone gaskets. With an easy self-adhesive application, the seals are available with a silicone flexible bubble compression seal, or a silicone flexible twin-fin wiping seal, to suit various glass door applications.

All seals are designed to suit 10mm and 12mm frameless glass doors, providing ambient and medium temperature smoke containment, along with draught and dust protection. The high performance silicone gaskets also protect glass doors from colliding during closure.

IS7340si and IS7345si suit 10mm glass
IS7350si and IS7355si suit 12mm glass

Gap size

- Min. 7mm / max. 9mm (prior to installation)

Standard lengths

- 2250mm
- Also available in: 250mm increments from 1000mm to 5000mm

Standard colours

Translucent UV stabilised polycarbonate with semi-transparent silicone bubble or twin-finned gasket

Approval/s

- Conforms with NCC Specification C3.4 smoke sealing requirements

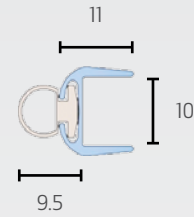

IS7340si

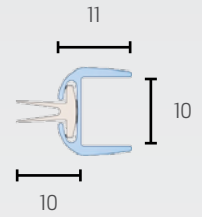

IS7345si

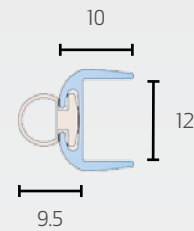

IS7350si

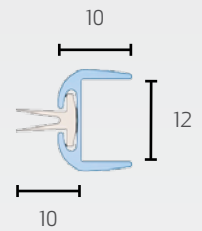

IS7355si

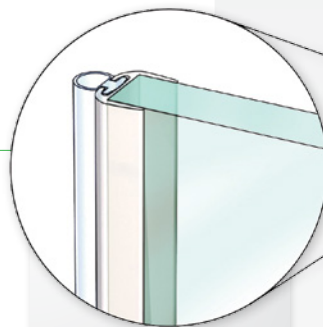

Above: IS7350si seal adhered to the 12mm glass door pivot stile. (Suitable for single or double swing applications).

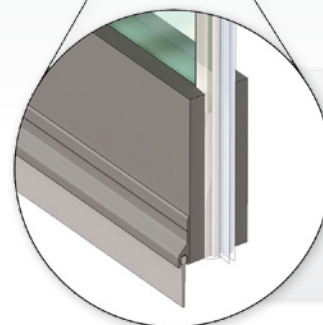
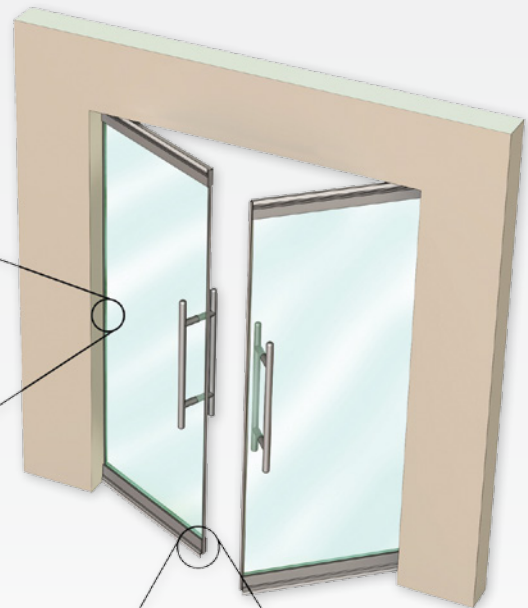

Left: IS7355si seals adhered to 12mm frameless glass pivot door meeting stile.

Also shown with an IS5111si sweep action door bottom seal.