



Door Closer

# DORMA TS 83

**New**

- ideal dimensions
- optimised features

## Easy to install and with adjustable closing force, backcheck and delayed action.

### Easy to fix and even easier to adjust. The door closer for almost every door size and application.

Decades of experience have gone into the development of the DORMA TS 83. The result is user comfort coupled with outstanding versatility. It can be adjusted to suit almost all types of door.

It can even be supplied with additional anti-corrosion protection for exposed applications or aggressive conditions.

Fixing couldn't be easier – and last but not least – it's engineered for excellence.

Certified to ISO 9001.

### Plus points

#### For the trade

- Low inventory costs and reduced stocking requirement thanks to streamlined product range.
- Practical and effective solutions to meet special applications thanks to comprehensive choice of accessories.

#### For the installer

- Easy to fix.
- Can be "tailored" to the requirements of the door by simple adjustment.
- Just one model for RH (DIN-R, ISO 5) and LH (DIN-L, ISO 6) doors, and for standard and frame/lintel fixing.
- Spring strength range EN 3–6 to suit virtually every application.

#### For the specifier/architect

- Compact closer design and sturdy flat-form arm assembly.
- Wide range of standard functions supplemented by optional extras.
- Suitable for fire doors.

#### For the user

- Optimum wall and door protection thanks to "thinking" backcheck.
- Closing speed virtually unaffected by temperature fluctuations.
- Proportionately low opening resistance thanks to high mechanical efficiency.

Data and features		TS 83	
Variable closing force	Spring strength	EN 3–6	EN 7
Standard doors <sup>1)</sup>	≤ 1400 mm ≤ 1600 mm	● –	– ●
External doors, outward opening <sup>1)</sup>	≤ 1400 mm ≤ 1600 mm	● –	– ●
Fire and smoke check doors <sup>1)</sup>	≤ 1400 mm ≤ 1600 mm	● –	– ●
Non-handed		●	●
Arm assembly type	Standard	○	○
	Flat-form	●	●
	Slide channel	–	–
Closing force variable by means of adjustment screw		●	–
Closing speed adjustable at 3 separate valves	180° - 70°	●	–
	70° - 15°	●	–
	15° - 0°	●	–
Closing speed variable by means of valve adjustment		–	●
Adjustable latching action	by arm	●	●
Backcheck	self-regulating	●	●
	adjustable at valve	●	●
Delayed action variable at valve		●	–
Hold-open		○	○
Weight in kg		1.7	3.3
Dimensions in mm	Length	245	293
	Overall depth	46	47.5
	Height	60	60
Approved to AS1905 Part 1			
Fire resistant doors		●	●
Door closer tested to EN 1154		●	●
CE mark for construction products		●	●
● yes – no ○ option			

<sup>1)</sup> For applications involving particularly heavy or wide doors, and doors which have to close against wind resistance, the next highest closer size or a higher spring strength should be applied.

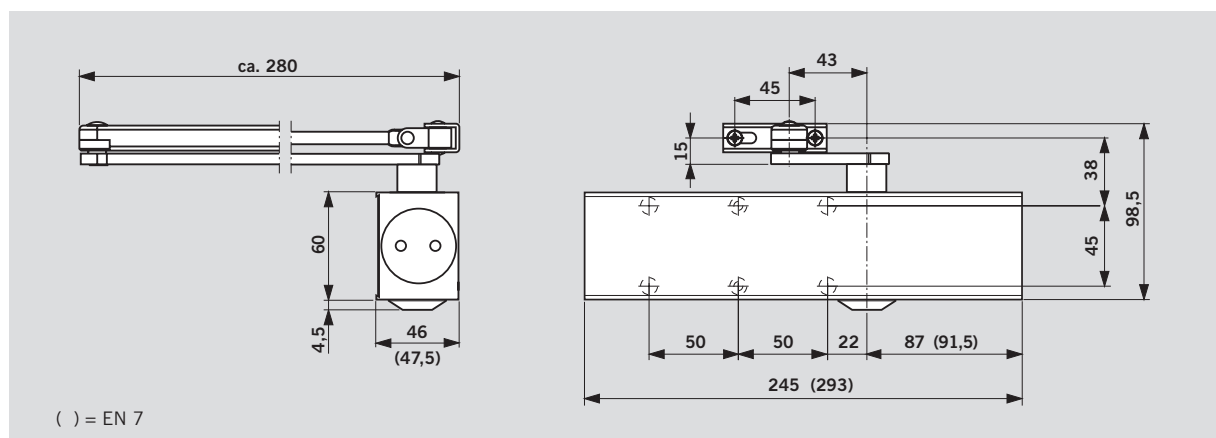

### Standard and optional functions

## With “thinking” backcheck – Model BC/ÖD

Thanks to an innovative design concept, the resistance developed by this backcheck system as the door is opened beyond approx. 70° is directly proportional to door acceleration. It is almost imperceptible when the door is opened slowly. However, if the door is opened hastily, the backcheck responds in equal measure.

And if the door should be flung open at speed – whether deliberately, thoughtlessly, accidentally or as a result of a gust of wind – the backcheck reacts at full strength, protecting the wall and door from damage.

**If no backcheck function is required, the system can simply be switched off.**

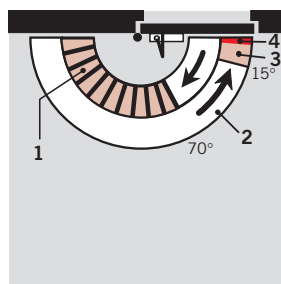

- 1 Self-regulating backcheck
- 2 Infinitely variable closing speed in the range 180° – 70°  
70° – 15°
- 3 Infinitely variable closing speed in the range 15° – 0°
- 4 Adjustable latch range (by arm)

## With additional delayed action – Model BC/ÖD + DC/SV

This model with its additional, integrated delayed action enables the closing cycle to be retarded within an adjustable range from 180° – 70° so that disabled persons, mothers with prams and people carrying bulky items are able to pass through the door without difficulty.

This model can also be used for fire doors.

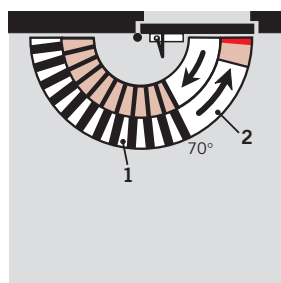
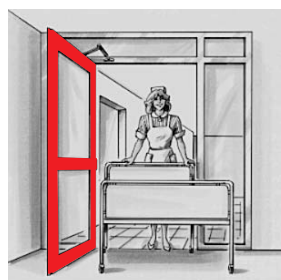

- 1 Adjustable delayed action
- 2 Fully controlled closing with adjustable speed

## With hold-open – Model with hold-open arm

Combining the TS 83 with a hold-open arm enables the door to be held open at an appropriate angle (up to approx. 150°).

The hold-open function in the standard hold-open arm can be switched on and off by the user by simply pressing a switch.

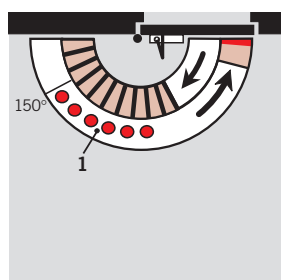
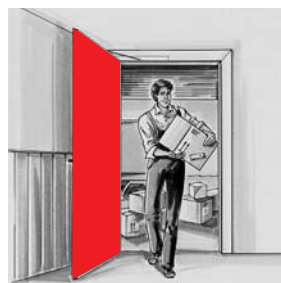

- 1 Hold-open range

**Hold-open arms are not approved for fire and smoke check doors.**

### Door leaf fixing, pull side

(example shows LH (ISO 6) door; RH (ISO 5) doors mirrored arrangement)

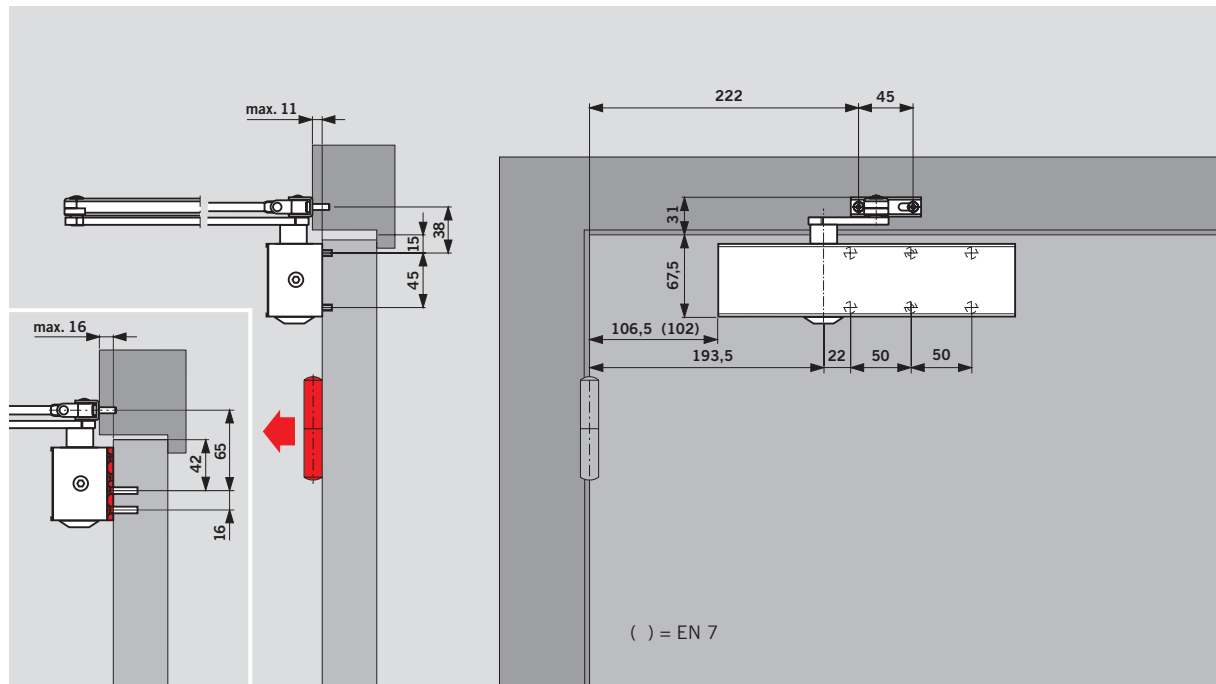

### Door leaf fixing, push side, parallel arm installation

(example shows RH (ISO 5) door; LH (ISO 6) doors mirrored arrangement)

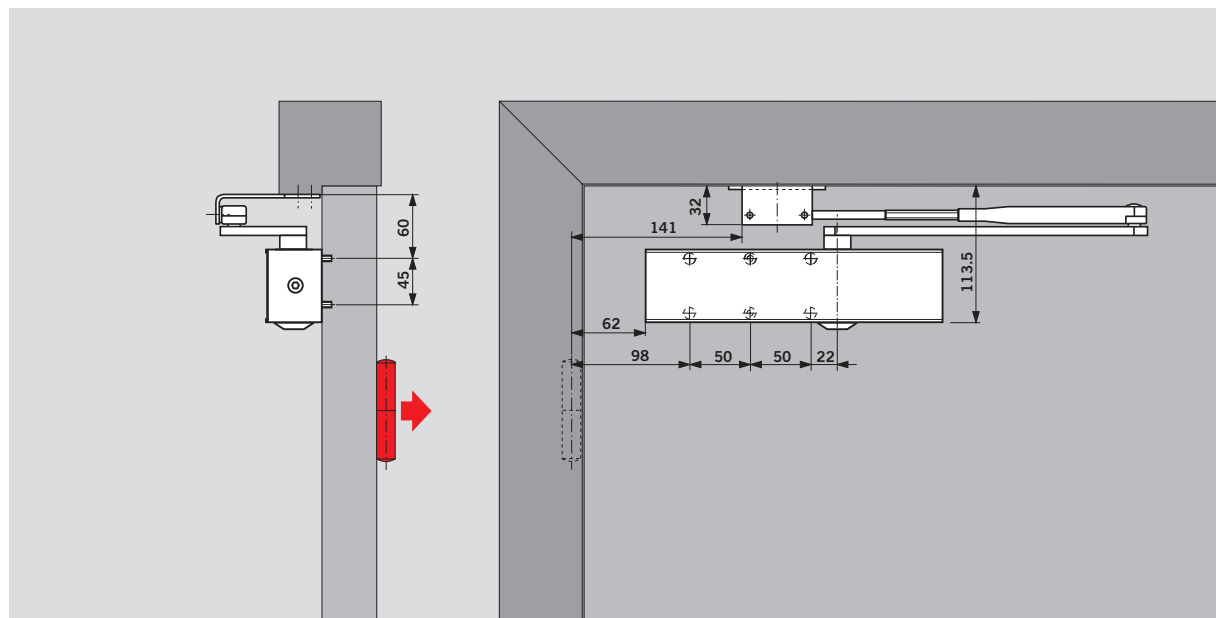

## Door leaf fixing with hold-open arm, pull side

(example shows LH (ISO 6) door; RH (ISO 5) doors mirrored arrangement)

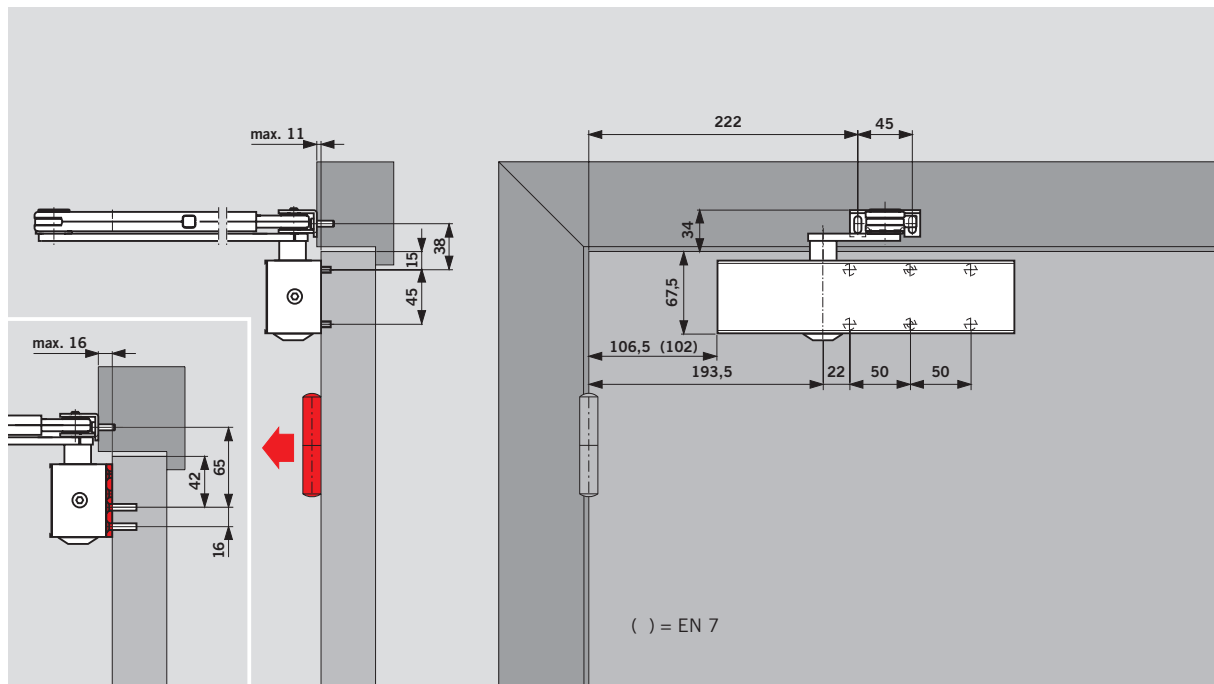

## Transom fixing, push side

(example shows LH (ISO 6) door; RH (ISO 5) doors mirrored arrangement)

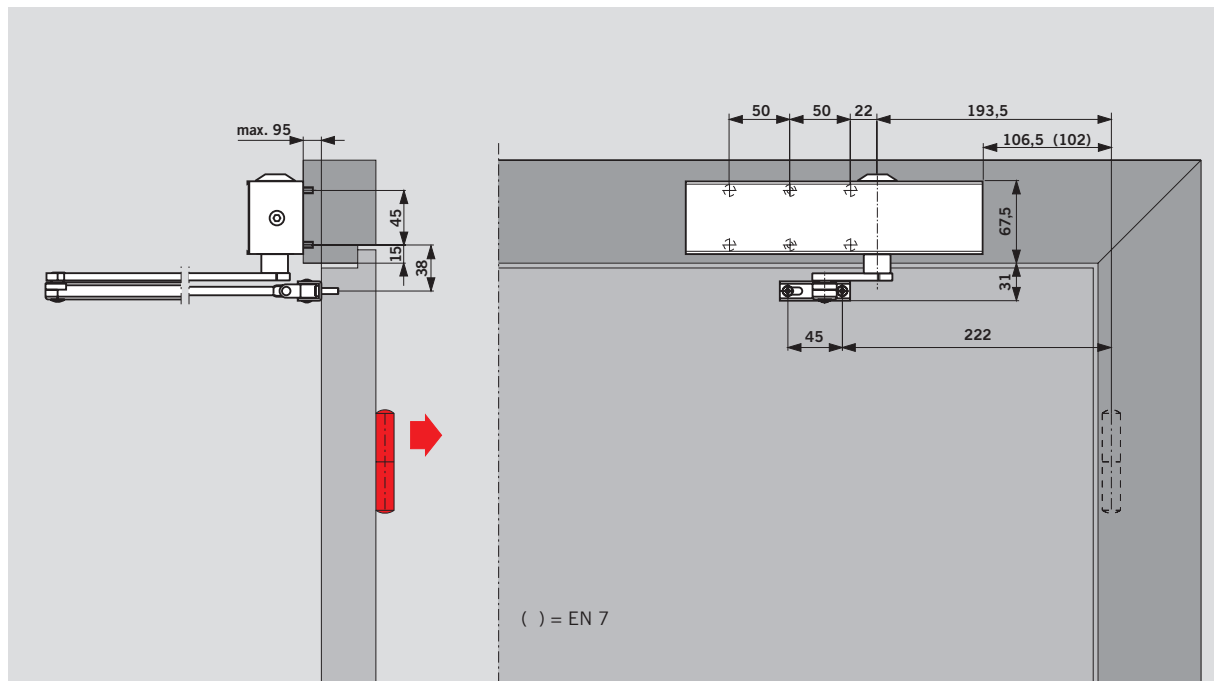

In the case of fire doors, door closers may only be transom-fixed where appropriate approval has been obtained in the form of a certificate or test report issued by an accredited testing agency.

### Transom fixing:

With transom-fixed closers, the backcheck only responds at between 85° and 90°, depending on the depth of reveal and type of door hinge involved; the delayed action, on the other hand, releases the door at an earlier point in its closing sweep.

**Mounting backplate**

For use with fire and smoke check doors and also as an intermediate plate when direct fixing to the door is not possible; with fixing hole pattern to EN 1154, supplement 1.

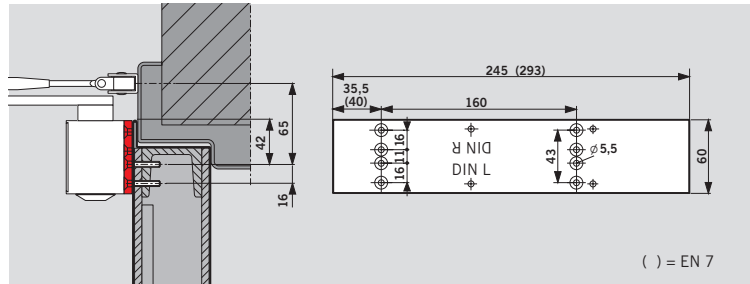

**Arm bracket adapter plate**

For fixing the arm bracket to particularly narrow door frames.

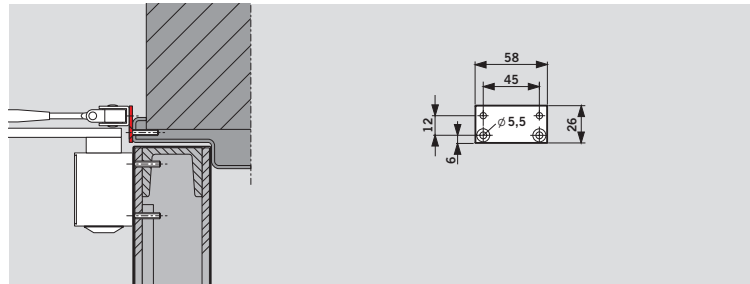

**Angle bracket**

For frame/lintel fixing of the closer on the push side of doors with deep reveals.

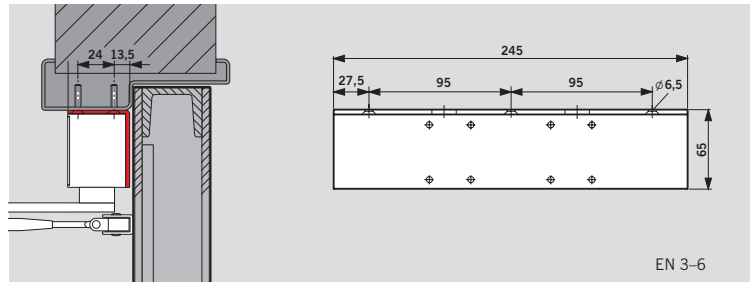

**Drop plate**

For installation on frame when direct fixing of closer is not possible.

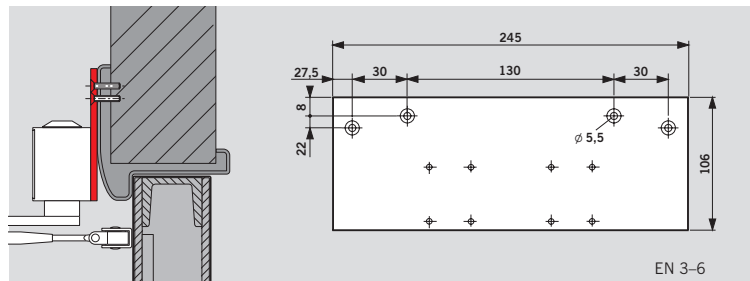

**Parallel arm bracket**

For parallel arm installation on the push side (see fixing instructions for dimensions).

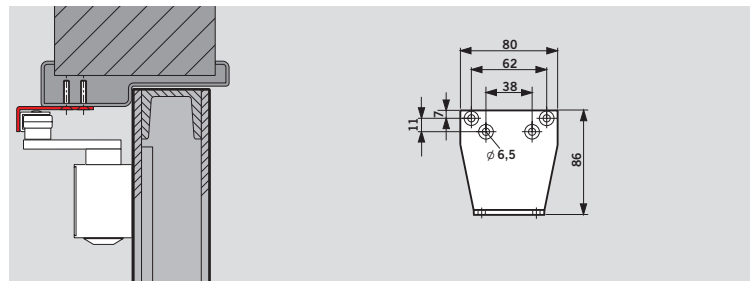

**Spindle extension**

For increasing the distance between the closer and the arm assembly in the case of doors with a high overlap; 16 mm high.

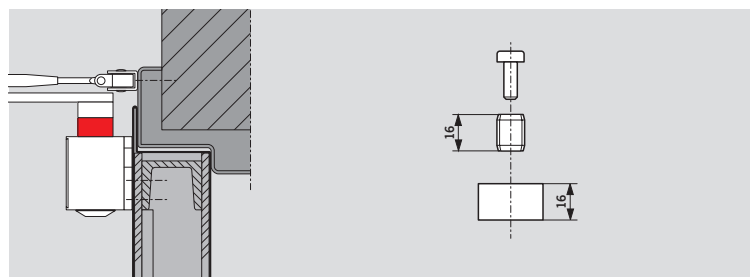

## Supply and accessory information

Closer body TS 83	Standard arm	Standard arm anti- corrosive type (AC)	Flat-form arm	Hold-open arm with on/off switch	Mounting backplate	Arm bracket adapter plate	Angle bracket	Drop plate	Parallel arm bracket	Spindle extension 16 mm
	220023xx	83000201	830001xx	220030xx	EN 3 – 6 380001xx EN 7 830011xx	830014xx	EN 3 – 6 380003xx	EN 3 – 6 380002xx	280066xx	83003705
Size EN 3 – 6 BC/ÖD+DC/SV ■		<input type="checkbox"/>	<input type="checkbox"/>	<input type="checkbox"/>	#	#	#	#	#	#
Size EN 3 – 6 BC/ÖD+DC/SV ■ 380201xx	<input type="checkbox"/>		<input type="checkbox"/>	<input type="checkbox"/>	#	#	#	#	#	#
Size EN 3 – 6 BC/ÖD (AC)		<input type="checkbox"/>			#	#	#	#	#	#
Size EN 7 BC/ÖD ■ 830602xx	<input type="checkbox"/>		<input type="checkbox"/>	<input type="checkbox"/>	#	#			#	#

Order No.:

■ = Body only

□ = Arm only

■□ = Closer with arm,  
complete

# = Optional accessory

Colour\*)

silver

white (RAL 9016)

other

xx

01

11

09

\*Anti-corrosion protected  
closers and arms  
available in silver (01)  
only.

## Specification text TS 83 EN 3 – 6

DORMA TS 83 rack and pinion door closer; with adjustable power size EN 3 – 6, according to EN 1154, carries the CE mark, integral self-regulating backcheck; closing speed adjustable in two independent ranges and adjustable latch action. Non-handed.

**Model**

- with additional, adjustable delayed action
- anti-corrosion protected (AC)
- with standard arm
- with flatform arm
- with hold-open arm with switch

**Accessories**

\_\_\_\_\_

**Colour**

- silver
- white (sim. RAL 9016)
- other  
(sim. RAL \_\_\_\_\_)

**Model make** DORMA TS 83

□ TS83

## Specification text TS 83 EN 7

DORMA TS 83 rack and pinion door closer; with power size EN 7, according to EN 1154, carries the CE mark, integral self-regulating backcheck; adjustable closing speed and adjustable latch range. Non-handed.

**Model**

- with standard arm
- with flatform arm
- with hold-open arm with switch

**Accessories**

\_\_\_\_\_

**Colour**

- silver
- white (sim. RAL 9016)
- other  
(sim. RAL \_\_\_\_\_)

**Model make** DORMA TS 83

□ TS83



[www.dorma.com](http://www.dorma.com)

## Door Control Division worldwide

### Central Europe

DORMA GmbH + Co. KG  
Breckerfelder Str. 42-48  
D-58256 Ennepetal  
Tel. +49 23 33/7 93-0  
Fax +49 23 33/7 93-4 95

### Australia

DORMA Door Controls Pty. Ltd.  
52 Abbott Road  
Hallam/Victoria 3803  
Australia  
Tel. +61 3 9796 3555  
Fax +61 3 9796 3955

### China

DORMA Door Controls (Suzhou)  
Co. Ltd.  
No. 9, Hong Feng Road  
Suzhou Singapore Industrial Park  
Suzhou, 215021  
P. R. of China  
Tel. +86 512/67612481  
Fax +86 512/67614582

DORMA Door Controls Pte. Ltd.  
Room 701, Technology Plaza  
651 King's Road  
North Point  
Hong Kong  
Tel. +825/250 34632  
Fax +825/288 75370

### Emerging Markets

DORMA GmbH + Co. KG  
Breckerfelder Str. 42-48  
D-58256 Ennepetal  
Tel. +49 23 33/7 93-0  
Fax +49 23 33/7 93-4 95

DORMA Door Controls (Pty.) Ltd.  
Kings Court, 4A Mineral Crescent  
ZA-2000 Crown/Gauteng  
South Africa  
Tel. +27 11/8 30 02 80  
Fax +27 11/8 30 02 91

### Far East

DORMA Far East Pte. Ltd.  
No. 31 Gul Lane,  
Singapore 629425  
Tel. +65 62 68/76 33  
Fax +65 62 65/79 14

### France

DORMA France S.A.S.  
Europarc  
42, rue Eugène Dupuis  
F-94046 Créteil  
Tel. +33 1/41 94 24 00  
Fax +33 1/41 94 24 01

### Gulf

DORMA Gulf Door Controls FZE  
Jebel Ali Free Zone,  
Roundabout 8,  
Unit VC 02  
Dubai, United Arab Emirates  
Tel. +971 48/83 90 14  
Fax +971 48/83 90 15

### North America

DORMA Architectural Hardware  
DORMA Drive, Drawer AC  
Reamstown, PA 17567  
Tel. +1-800-523-8483  
Fax +1-800-274-9724

### Scanbalt

DORMA Danmark A/S  
Sindalvej 6 - 8  
DK-2610 Rødovre  
Tel. +45 44/54 30 00  
Fax +45 44/54 30 01

### South America

DORMA Sistemas de Controles  
para Portas Ltda.  
Av. Piracema, 1400  
Centro Empresarial Tambore  
CEP 06400 Barueri/  
São Paulo, Brasil  
Tel. +55 11/41 91 32 44  
Fax +55 11/41 91 21 93

### South-East Europe

DORMA AUSTRIA GmbH  
Pebering Strass 22  
A-5301 Eugendorf  
Tel. +43 62 25/2 84 88  
Fax +43 62 25/2 84 91

### South Europe

DORMA Italiana S.r.l.  
Via. A. Canova 44/46  
I-20035 Lissone (MI)  
Tel. +39 039/24 40 31  
Fax +39 039/24 40 33 10  
DORMA Ibérica, S.A.  
Camino San Martin de la Vega, 4  
E-28500 Arganda del Rey  
(Madrid)  
Tel. +34 91/8 75 78 50  
Fax +34 91/8 75 78 81

### UK/Ireland

DORMA UK Ltd.  
Door Controls Division  
Wilbury Way  
Hitchin  
Hertfordshire SG4 0AB  
Tel. +44 14 62/47 76 00  
Fax +44 14 62/47 76 01



Door Control



Automatic



Glass Fittings  
and Accessories



Security/Time  
and Access (STA)



Movable Walls



4 021226 1518409