



FEATURES

Heavy duty formed steel (1.6mm) automatic hand dryer with sensor operation. Large fan and motor assembly provides a high performance dryer designed for high traffic areas and heavy use. Easy installation with tamper-proof locking.

INSTALLATION OPTIONS

Electrical connection by cord & plug (as supplied). Can be direct wired by an electrician.

SPECIFICATION

- Electrical Supply: AC, 220-240V 50Hz 10A
- Motor: 200 Watt 5500 RPM
- Element: 2200 Watt protected by thermal cut-out
- Air Speed: 21m/s (75.6 km/hr)
- Noise Level: 70±3dB-A
- Weight: Gross 6.2kg, Shipping 7kg
- Certificate of Suitability No: SAA140139
- Electrical Safety Requirement: AS/NZS 60335.2.23:2004
- Protection category: IPX3

FINISH

White epoxy enamel baked-on coating with silver gloss nozzle.

RECOMMENDED INSTALLATION HEIGHT

Men's washroom	1270mm
Women's washroom	1194mm
Children's washroom ages 4-7	889mm
Children's washroom ages 8-10	991mm
Children's washroom ages 11-13	1092mm
Children's washroom ages 14-16	1194mm
Accessible Compliant washroom	1016mm



WARRANTY

Component parts are guaranteed to be free of defects in material and workmanship for a period of 10 years, Transportation, freight costs and labour are excluded after the first 12 months. Please refer to the manual for further details.

Autobeam White with Silver Gloss Nozzle shall be Model No. HDABWHTSG as supplied by ASI JD MacDonald.

All ASI JD MacDonald disabled compliant products when installed must be in accordance with AS1428 to ensure the specified product is complying with all washroom specification requirements.

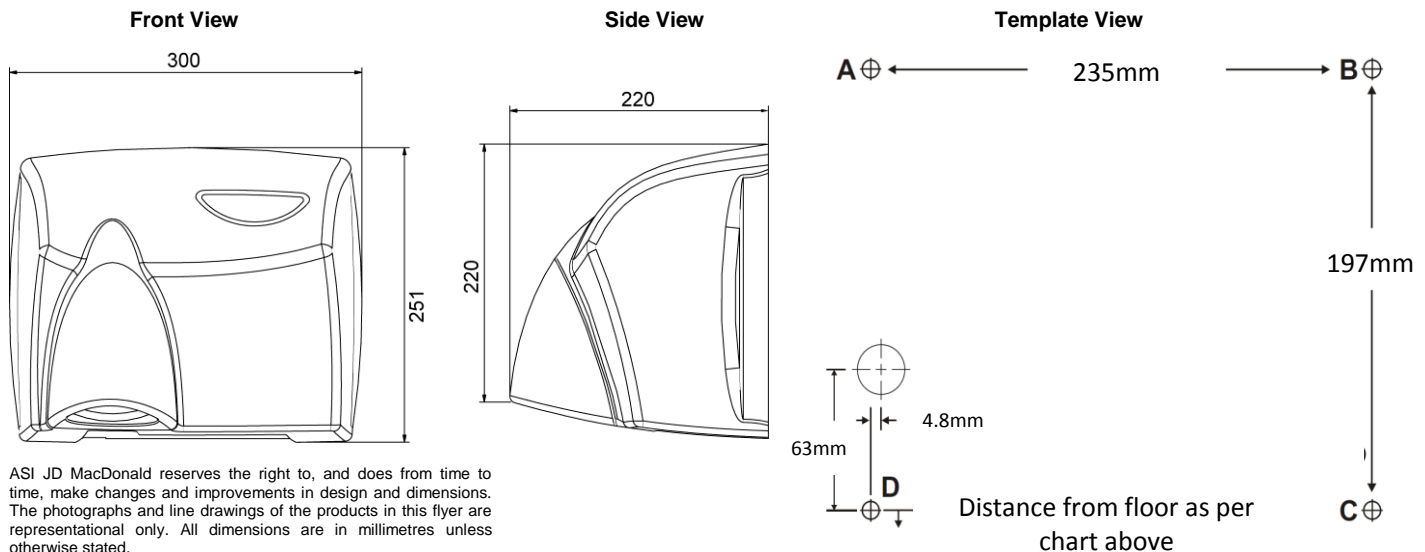

ASI JD MacDonald reserves the right to, and does from time to time, make changes and improvements in design and dimensions. The photographs and line drawings of the products in this flyer are representational only. All dimensions are in millimetres unless otherwise stated.