













Architectural, Acoustic, Smoke & Fire Containment Systems

	Introduction	1 - 5
	Product Selector	6 - 9
	Perimeter Seals	10 - 15
	Drop Seals	16 - 25
	Door Bottom Seals	26 - 28
	Threshold Plates	29 - 32
	Brush Seals	33 - 36
	Finger Protection	37
	Combined Fire & Smoke Seals	38 - 44
	Fire Door Upgrade Seals	45 - 46
	Fire Door Ventilation Grilles	47
	Aura® Architectural Seals	48 - 54
	Additional Information & Testing & Technical Services	55 - 57

Lorient has an international reputation for designing and manufacturing a wide range of innovative door sealing solutions for the containment of fire, smoke, sound and energy.

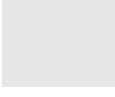
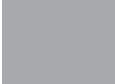
With almost 40 years of accumulated knowledge we pride ourselves on offering products that are designed to save lives, preserve property and enhance quality of life. We recognise our responsibility to create well-designed products that will perform; products which are durable and reliable, and which genuinely improve the buildings they protect. By doing so, we can play our part in improving life safety and reducing building damage and loss.

Having had a presence in Australia since 1986 the Lorient brand is well established and respected. Operating out of our new premises in Sydney NSW we are proud to offer our comprehensive range of architectural seals, high quality intumescent seals, medium temperature smoke seals and acoustic seals to the Australian and New Zealand markets.

We also have a number of operations around the world; in North America, Hong Kong, Europe, Singapore and Dubai with our Head Office in the UK. We also have strong links in India, which means that we're able to deliver the right solutions locally to our customers throughout the world.

By keeping abreast of technical developments and changes to codes, regulations and standards across the continents, we can ensure we're always providing the highest level of expertise. A trusted source for advice concerning testing, new product development or actual manufacture. We are always willing to partner and assist.













The Lorient Architectural Seals range incorporates a variety of complementary door sealing systems including perimeter seals, drop seals, threshold plates, door bottom seals plus much more. These seals can provide outstanding protection for all four sides of the door including sound, fire, smoke, light or energy and restrict unwanted nuisances such as draughts or insects.

Manufactured to the highest quality, Lorient Architectural Seals have been designed and tested for a host of different sectors including commercial, industrial and public buildings. Many of these sealing systems can easily be adjusted without the need to remove the door.

The AURA® range embraces a discerning selection of perimeter seals and threshold ramps - all with strong design accents. Every detail of the AURA® product range is considered and designed to integrate more successfully into beautifully designed doorsets and floors. A number of signature design details feature within the AURA® range; including a distinctive curved profile, which not only creates a sophisticated visual aesthetic, but also spreads and diffuses sound.

At-a-Glance Seal Function

The following icons are used throughout this brochure to give clear and easy recognition of a particular seal's function or possible application. Use of the icons does not necessarily indicate that test evidence exists. Please check with the Lorient team.

-  Fire
-  Smoke (DTS)
-  Medium temperature smoke
-  Hot smoke
-  Sound
-  Light
-  Weather
-  Draughts and dust
-  Insects
-  Wheelchair friendly
-  Bushfire
-  Anti-microbial protection

Product Illustrations

All dimensions in this brochure are in millimetres.

Standards and Regulations

In Australia, building construction is regulated under a framework of provisions detailed within the National Construction Code and associated Building Code of Australia. These codes set out a uniform set of technical provisions that allow for the design and construction of buildings; they also make reference to a number of Australian and International standards to ensure that materials, systems, products and services provide a consistent and quantifiable performance level.



Regulations & Standards relating to the containment of Fire, Smoke, Sound, Energy and Weather

Fire and smoke protection measures are essential, lifesaving precautions in a building. What's more, they protect the property from the devastating consequences of the fire itself, and the damaging effects of hot and cold smoke. So it is essential to get the product selection right, every time.

Section C of the BCA details the fire protection requirements for building designs and is written to ensure safe evacuation of occupants and minimise the fire risk to adjoining property.



Fire door assemblies

Fire resistant door assemblies are referenced in BCA Section C3 (specification C3.4.2) and are required to comply with Australian standard AS1905.1.

AS1905.1 Components for the fire protection of openings in fire resistant walls Part 1: Fire doors

This standard specifies the construction and installation requirements for side hung, pivoted and sliding fire door assemblies. It provides detailed guidance on installation of door frames, as well as acceptable clearances allowed around the edges of the installed door leaf. This standard also outlines fire testing requirements for hardware fitted to the fire door and guidance on permissible variations. The fire resistance level (FRL) of a fire door and any constituent hardware is determined by fire testing a representative sample in accordance with AS1530.4.

AS1530.4: 2014 Fire resistance tests of elements of building construction

This standard provides a fire test methodology and a set of exposure conditions that allows a building element's fire resistance level (FRL) to be determined. A FRL is designated according to the test element's ability to maintain its structural adequacy, integrity and its insulation values, and are expressed in this order.

The Lorient range of Architectural door sealing solutions have been extensively fire tested in accordance with AS1530.4 on most brands of fire door currently manufactured in Australia.

Please refer to the "Specification of Fire Rated Door Hardware" section at www.lorient.com.au for a full listing of approvals, fire resistance rating and applicable door types.

Smoke Doors

When fire breaks out in a building the risk to life safety is two-fold. Firstly there is the fire itself and the buoyant hot smoke generated in the immediate vicinity. Secondly there is the cooler smoke and toxic gases which, if unimpeded will rapidly spread through the building, threatening people and property some distance from the fire. Smoke doors provide a physical barrier that restricts the spread of smoke, assisting the occupants evacuation by ensuring egress routes remain clear and tenable.



Smoke control door assemblies - Deemed To Satisfy Construction (DTS)

Smoke doors are referenced by the BCA in section C, Specification C3.4. This section outlines the general scope and requires that a smoke door must be constructed so that smoke will not pass from one side to the other and if it's glazed there is minimal danger of a person being injured by accidentally walking into them. The clause also provides a deemed to satisfy construction as follows;

(a) The leaves are side-hung and swing (i) in the direction of egress; or (ii) in both directions.

b)(i) The leaves are capable of resisting smoke at 200°C for 30 minutes.

(ii) Solid-core leaves* at least 35mm thick satisfy (i).

(c) The door leaves are fitted with smoke seals.

(d)(i) The leaves are normally in the closed position; or

(a) The leaves are closed automatically with the automatic closing operation initiated by smoke detectors, installed in accordance with the relevant provisions of AS 1670.1, located on

each side of the doorway not more than 1.5m horizontal distance from the doorway; and (b) In the event of power failure to the door, the leaves fail-safe in the closed position.

(e) The leaves return to the fully closed position after each manual opening.

(f) Any glazing incorporated in the door complies with AS 1288.

(g) (i) If a glazed panel is capable of being mistaken for an unobstructed exit, the presence of the glass must be identified by opaque construction.

(ii) An opaque mid-height band, mid-rail or crash bar satisfies (i).

Fire engineered smoke door specifications (performance-based)

The BCA permits the use of "Performance Based Alternative Solutions" and Fire Engineers now frequently reference two Australian Standards to create a comprehensive specification that details maximum leakage requirements for a complete door assembly and a test methodology that allows actual leakage rates to be determined. The two standards that are commonly referenced are: AS6905:2007 and AS1530.7:2007.

AS6905:2007 - Smoke doors

This standard outlines the construction, installation and identification requirements for a complete smoke door assembly. Importantly this standard also provides guidance on the maximum acceptable leakage rates for both single and double leaf door assemblies. Smoke leakage rates are determined by subjecting a door assembly to the test method detailed AS1530.7.

AS1530.7:2007 - Methods for fire tests on building materials, components and structures. Part 7 - Smoke control assemblies - ambient and medium temperature leakage test procedure

This standard provides a methodology to measure and quantify the leakage of both ambient and medium temperature air through a door assembly. The test procedure involves mounting a door into a sealed chamber and heating the air within to a temperature of 200°C and maintaining this for a period of 30 minutes. At various stages pressures are induced within the chamber and the corresponding leakage measurement logged and reported.

Acoustic sealing systems for door assemblies

Door assemblies are an integral part of buildings, and while there must be gaps around their perimeter to operate efficiently, left unsealed these clearances allow sound to pass freely. Lorient's solution is to provide sealing options for all four sides of the door that create a physical barrier to ensure effective acoustic separation is achieved.



Acoustic regulations

Section F the Building Code of Australia (BCA) covers Sound Transmission within buildings and includes a set of construction and performance requirements to ensure occupants do not suffer illness or loss of amenity as a result of unwanted sound transmission.

Acoustic provisions

The provisions outlined in Section F relate to certain building classifications and these include:

- Class 2: Multi residential / sole occupancy apartment buildings
- Class 3: Hotels, Motels and Boarding houses
- Class 9C: Aged care facilities.

Section F5.5.b requires a door assembly incorporated into a wall in a Class 2 or 3 building separating a sole occupancy unit from a stairway, corridor or public space to have an acoustic performance of not less than **30Rw** - when determined by acoustic standards AS/NZS1276.1 or AS/ISO717.1.

Acoustic test methods acoustic test methods and related standards

Test method and expression of results

The AS1191 or ISO 10140.2 (formerly ISO 140.3) acoustic test method involves placing a representative door construction within a dividing wall between a reverberant "Source Room" and "Receiving Room". Sound waves are produced by a loudspeaker in the Source Room and microphones are used to obtain an average of the sound pressure levels within each room in the frequency range 100 to 5000 Hertz (Hz). From these laboratory measurements, the Sound Reduction Index (R) is derived by calculating the recorded results in accordance with AS/NZS ISO 717.1 The output is plotted as a curve at one-third octave intervals between 100Hz & 3150Hz and this final weighted sound reduction index value is expressed as R_w .

Acoustic sealing efficiency

It should be noted that Lorient sealing systems are acoustically tested full size

in their normal everyday operational mode under laboratory conditions.

To evaluate the acoustic efficiency Lorient conduct a series of three tests which include:

- An initial test with the door in a unsealed condition (known as un-caulked), this provides the minimum level of performance the door can achieve with no seals.
- The same door is fitted with a sealing arrangement and re-tested to determine performance improvement.
- The door perimeter is sealed with a high density acoustic putty and re-tested to ascertain much sound is actually passing through the door leaf – (this final test reveals the maximum potential performance that the door can achieve).

By comparing these three results it is possible to determine the sealing system efficiency and maximum potential performance of the door assembly under evaluation.

Effective acoustic sealing selection

Wherever noise influences human activity, effective acoustic sealing is essential. Whether preserving the confidentiality of discussions in a private office or doctor's surgery, or reducing noise from adjacent rooms in hotels; preservation of privacy is paramount.



Relevant standards

The following standards relate to the testing and evaluation of acoustic doors:

ISO 10140.2: 2010 (formerly ISO 140.3: 1995): Methods of measurement of sound insulation in buildings and of building elements. Laboratory measurement of airborne sound insulation of building elements.

AS1191 AS 1191-2002 - Acoustics - Laboratory measurement of airborne sound transmission insulation of building elements.

AS/NZS ISO 717-1: 1997: Rating of sound insulation in buildings and of building elements. Part 1 Airborne sound insulation.

On-site considerations

The sound reduction performance of any system will vary according to the incident frequency of the sound waves to which it is exposed and whilst laboratory tests provide a standardised data of comparison, they should not be relied upon as a guarantee of performance of on-site installations.

Factors such as flanking paths, wall, floor and ceiling construction, room volumes and surface finishes all have a significant influence on acoustic performance.

Furthermore it should be noted that quality of workmanship relating to the installation and fitting of seals can also greatly influence final acoustic efficiency.

Perimeter Seals

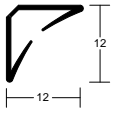

LAS1212
Batwing®

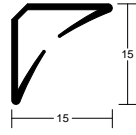

LAS1515
Batwing®



LAS1011

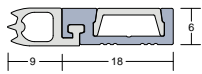

LAS7001 si

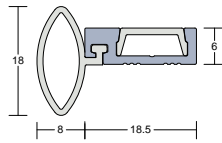

LAS7003 si

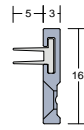

LAS7004 si

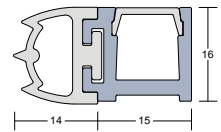

LAS7005 si

Drop Seals

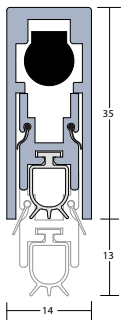

LAS8001 si

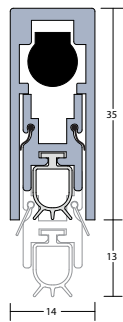

LAS8002 si

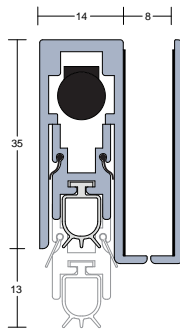

LAS8002G LH

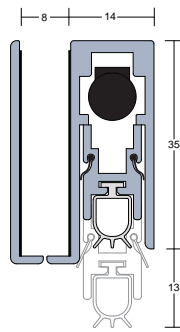

LAS8002G RH

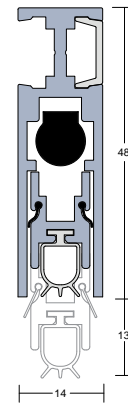

LAS8003 si

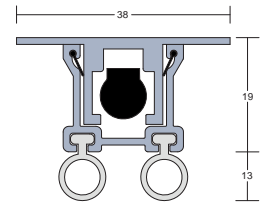

LAS8004 si

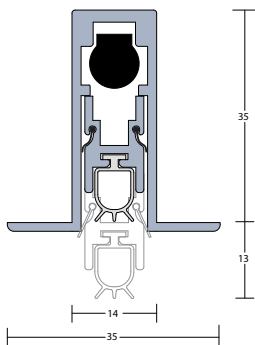

LAS8005 si

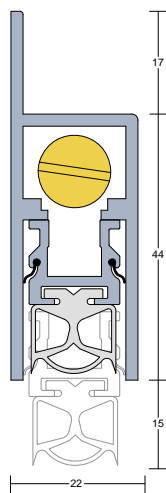

LAS8006 si

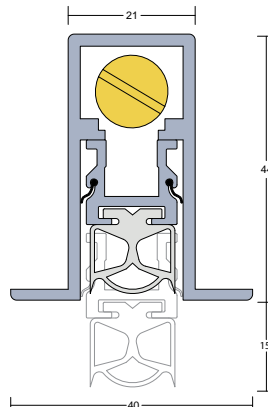

LAS8007 si

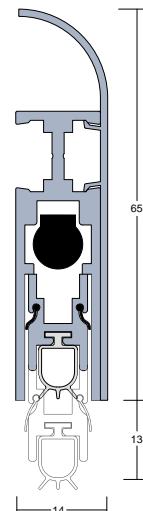

LAS8008 si

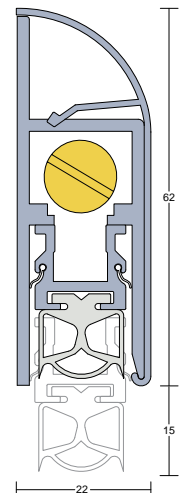

LAS8009 si

AURA®

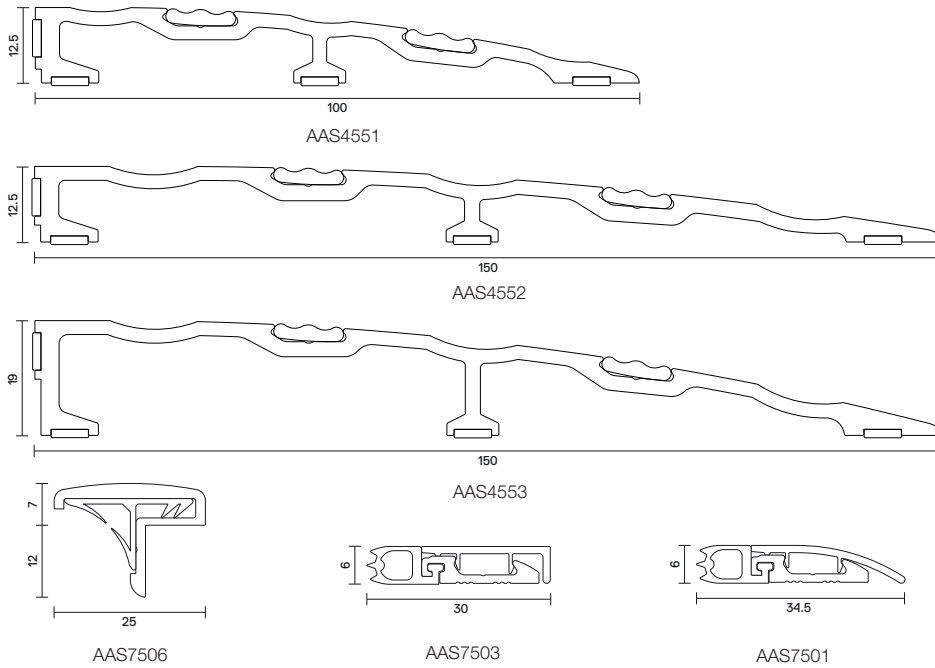

Threshold Plates & Ramps

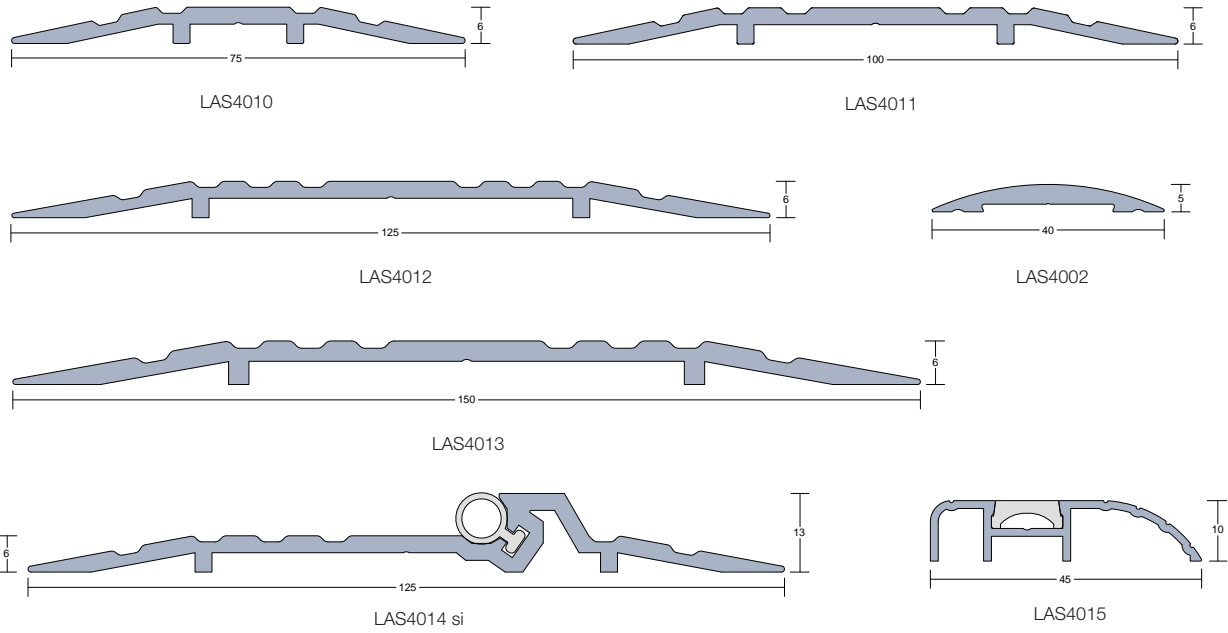

Door Bottom Seals

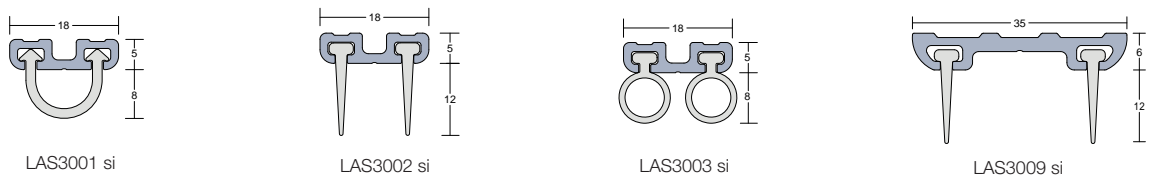

Door Bottom Seals

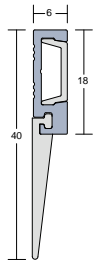

LAS3004 si

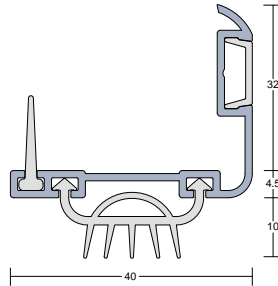

LAS3007

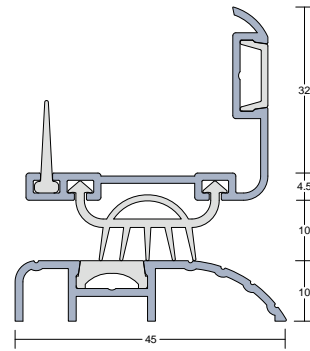

LAS3008

Brush Seals

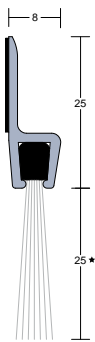

LAS5020

- *Also
 13mm - LAS5010
 19mm - LAS5015
 35mm - LAS5025
 45mm - LAS5030

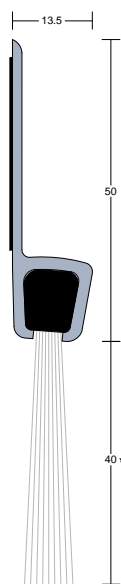

LAS5035

- *Also
 60mm - LAS5040
 80mm - LAS5045
 120mm - LAS5050
 150mm - LAS5055

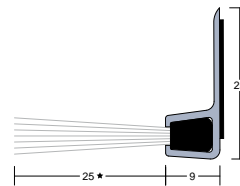

LAS5060

- *Also
 35mm - LAS5065H
 45mm - LAS5070H

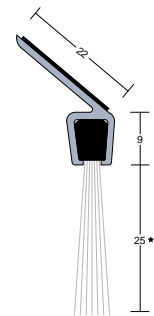

LAS5075

- *Also
 35mm - LAS5080
 45mm - LAS5085

Combined Intumescent Fire & Hot Smoke Seals

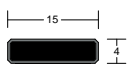

LP series

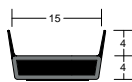

DS series

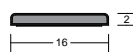

LAS1602

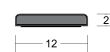

LAS1202

Combined Intumescent Fire & Hot Smoke Seals

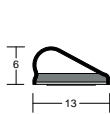

LAS1602BB

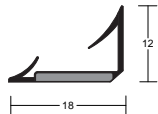

LAS1812LSS

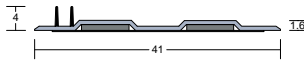

LAS400TF

Fire Door Upgrade Seals

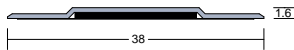

Lorient Door Perimeter Upgrade LDPU

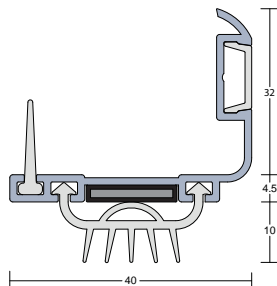

Lorient Door Bottom Upgrade LDBU

Fire Rated Air Transfer Grilles for Fire Doors

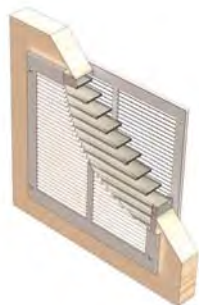

LVH Fire Door Air Transfer Grille

Finger Protection



LAS9050 Hinge Guard Seal

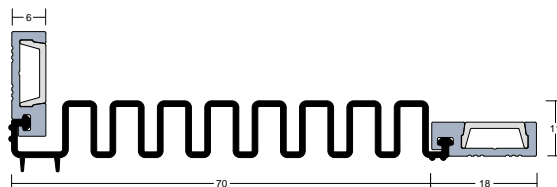

LAS9070 Finger Guard Seal

LAS1212 & LAS1515 Batwing® Seals

Medium Duty

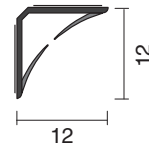

LAS1212
Batwing®

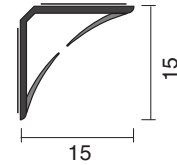

LAS1515
Batwing®



Description

The Lorient Batwing® series is primarily designed to contain sound and restrict the spread of medium temperature smoke around hinged door assemblies. Their symmetrical design and unique curved sealing fins provide outstanding performance benefits.

Key benefits

Seals restrict the spread of medium temperature smoke (200°C).
Highly effective acoustic seal that can be retrofitted to existing door assemblies.
Low friction curved elastomeric fins spring back to original shape to provide continuous performance.
Discreetly positioned in frame rebate to provide a fully concealed sealing solution.
Simple peel-and-stick installation, our aggressive self-adhesive backing is tested on many surfaces to ensure seal longevity.
Seal surface and fins contain anti-microbial additives to restrict bacterial growth.

Approvals

Fire: Tested in accordance with AS1530.4 on proprietary AS1905.1 fire door assemblies for up to 4 hour rating.

Smoke: AS1530.7 smoke test data on AS6905 compliant smoke door assemblies.

Sound: Acoustically tested in accordance with ISO10140-2 and AS/NZS717.1 with ratings up to 39Rw on appropriate rated assemblies.

Durability: Long term mechanical test, completing 1,000,000 cycles without failure.

Standard lengths

1m, 2.1m and 2.75m.

Single doorset pack (SDP): (1 x 1m, 2 x 2.1m)

Long single doorset pack (LSDP): (1 x 1m, 2 x 2.75m)

Double doorset pack (DDP): (3 x 2.1m)

Long double doorset pack (LDDP): (1 x 2.1m, 2 x 2.75m).

Fixing method

Aggressive film backed self-adhesive.

Gap sizes

LAS1212 – 2-3mm.

LAS1515 – 3mm.

Finishes

Standard colours: Black and clear.

White, grey and brown available to special order.

(Note: Clear does not restrict light penetration).



LAS1212 Batwing®
shown with LAS8001 si
drop seal

LAS1011 Firtree™ Seal

Medium Duty

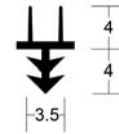

LAS1011
Firtree™

■ Description

The Firtree™ seal comprises a barbed spine that incorporates two flexible sealing fins. It simply push-fits into a 3mm wide x 5mm deep groove to provide an effective acoustic seal.

■ Key benefits

Ideal for double swing door applications as seal allows bypass of pivot hardware.
Simply push fits into a pre-prepared groove.
Fins are co-extruded to spine for reliable long term durability.
Seal surface and fins contain anti-microbial additives to restrict bacterial growth.

■ Approvals

Fire: Approved for use on proprietary AS1905.1 fire doors for up to 4 hour fire rating.

Smoke: Conforms with BCA Specification C3.4 smoke sealing requirements.

Sound: Acoustically tested in accordance with ISO10140-2 and AS/NZS717.1 with ratings up to 38Rw on appropriate rated assemblies.

Durability: Long term mechanical test, completing 1,000,000 cycles without failure.

■ Standard lengths

2.1m and 2.75m.

■ Fixing method

Friction fit into 3mm wide x 5mm deep groove.

■ Gap sizes

2mm - 3mm.

■ Finish

Standard colour: Black with black fins.



LAS1011 Firtree™ seal
shown fitted to door
edge

LAS7001 si Perimeter Seal

Medium Duty

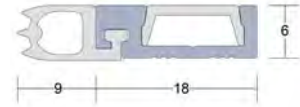

LAS7001 si

Description

A slim-line, stop mounted compression seal incorporating an anodised aluminium carrier fitted with a fire rated silicone rubber gasket and non-shrink, click-fit cover strip. The seal is fitted to the head and jambs of the door frame to create an effective seal between the frame and the door face.

Key benefits

A slim-line and unobtrusive acoustic seal that can easily be retrofitted to existing door assemblies. Fitted with high performance fire rated silicone rubber gasket. Supplied with slotted fixing holes for accurate positioning and easy adjustment. Non-shrink, click-fit cover strip conceals the fixing points.

Approvals

Fire: Tested in accordance with AS1530.4 on proprietary AS1905.1 fire door assemblies for up to 4 hour rating.

Sound: Acoustically tested in accordance with ISO10140-2 and AS/NZS717.1 with ratings up to 39Rw on appropriate rated assemblies.

Durability: Long term mechanical test, completing 1,000,000 cycles without failure.

Standard lengths

1m, 2.1m and 2.75m.

Single doorset pack (SDP): (1 x 1m , 2 x 2.1m)

Long single doorset pack (LSDP): (1 x 1m, 2 x 2.75m)

Double doorset pack (DDP): (3 x 2.1m)

Long double doorset pack (LDDP): (1 x 2.1m, 2 x 2.75m).

Fixing method

Screw fixed to the door frame with supplied screw pack.

Gap sizes

Accommodates and seals gaps from 0mm to 8mm.

Finishes

Silver anodised aluminium with grey silicone rubber gasket and click-fit cover strip.



LAS7001 si shown fitted to door frame

LAS7003 si Perimeter Seal

Medium Duty



Description

A slim-line, stop mounted compression seal incorporating an anodised aluminium carrier fitted with an elliptical fire rated silicone rubber gasket and non-shrink, click-fit cover strip. The seal is fitted to the head and jambs of the door frame to create an effective seal between the frame and the door face.

Key benefits

Simple and effective acoustic seal that can easily be retrofitted to existing door assemblies.

Slim-line and unobtrusive.

Fitted with a smooth high performance fire rated silicone rubber gasket.

Supplied with slotted fixing holes for accurate positioning and easy adjustment.

Non-shrink, click-fit cover strip conceals the fixing points.

Approvals

Approved for use on proprietary AS1905.1 fire doors for up to 4 hour fire rating.

Sound: Acoustically tested in accordance with ISO10140-2 and AS/NZS717.1 with ratings up to 40Rw on appropriate rated assemblies.

Durability: Long term mechanical test, completing 1,000,000 cycles without failure.

Standard lengths

1m, 2.1m and 3m. Single doorset pack consisting of 1 x 1m and 2 x 2.1m. Other lengths to special order.

Fixing method

Screw fixed to the door frame with supplied screw pack.

Gap sizes

Accommodates and seals gaps from 3mm to 7mm.

Finishes

Silver anodised aluminium with grey silicone rubber gasket and click-fit cover strip.

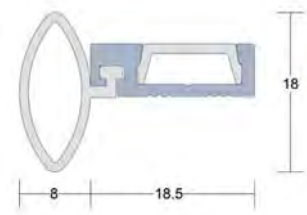

LAS7003 si



LAS7003 si shown fitted to door frame

LAS7004 si Perimeter Seal

Medium Duty



Description

Designed for use around the perimeter and meeting stiles of single or double swing doors.

Key benefits

- Effective sealing solution for smoke, sound, light or weather.
- Acoustic data available in accordance with ISO10140.2.
- Durable silicone rubber finned gasket.
- Suitable to meet DTS smoke door specification C3.4.
- The leg of this seal can be cut out to accommodate lock hardware.
- May be surface mounted or semi mortised.
- Tested for reliability, the seal completed 1,000,000 cycles without failure.

Approvals

Sound: Acoustically tested in accordance with ISO10140-2 and AS/NZS717.1 with ratings up to Rw38 on appropriate rated assemblies.

Location

Meeting stiles of single and double swing doors.
Sliding doors.

Seal material

Silicone rubber.
Note: twin elastomeric fins will provide optimum acoustic performance.

Standard lengths

1m and 2.1m. Other lengths to special order.

Fixing

Fixing screws are supplied. Fixing holes are pre-drilled and countersunk.

Finishes

Silver anodised aluminium with grey twin fin silicone rubber insert.

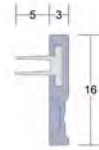

LAS7004 si



LAS7004 si shown fitted to meeting stiles

LAS7005 si Perimeter Seal

Heavy Duty

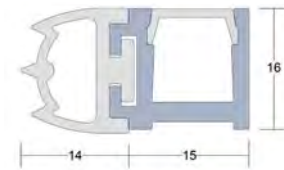

LAS7005 si

Description

A robust stop mounted compression seal incorporating an anodised aluminium carrier fitted with fire rated silicone rubber gasket and non-shrink, click-fit cover strip. The seal is fitted to the head and jambs of the door frame to create an effective seal between the frame and the door face.

Key benefits

Compact and effective acoustic seal that can easily be retrofitted to existing door assemblies. Fitted with high performance fire rated silicone rubber gasket. Supplied with slotted fixing holes for accurate positioning and easy adjustment. Non-shrink, click-fit cover strip conceals the fixing points.

Approvals

Fire: Tested in accordance with AS1530.4 on proprietary AS1905.1 fire door assemblies for up to 4 hour rating.

Sound: Acoustically tested in accordance with ISO10140-2 and AS/NZS717.1 with ratings up to 33Rw on appropriate rated assemblies.

Standard lengths

1m, 2.1m and 2.75m.

Single doorset pack (SDP): (1 x 1m, 2 x 2.1m)

Long single doorset pack (LSDP): (1 x 1m, 2 x 2.75m)

Double doorset pack (DDP): (3 x 2.1m)

Long double doorset pack (LDDP): (1 x 2.1m, 2 x 2.75m).

Fixing method

Screw fixed to the door frame with supplied screw pack.

Gap sizes

Accommodates and seals gaps from 0mm to 10mm.

Finishes

Silver anodised aluminium with grey silicone rubber gasket and click-fit cover strip.

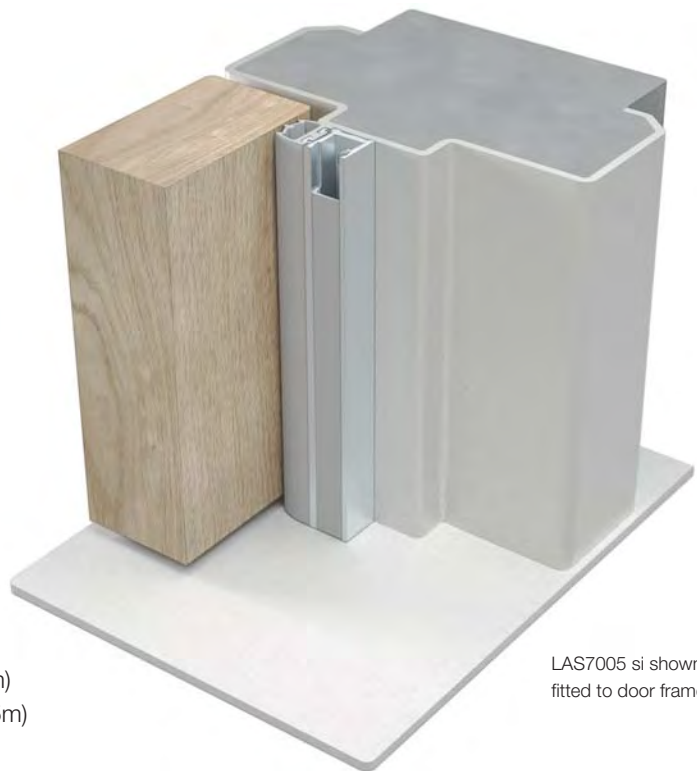

LAS7005 si shown fitted to door frame

LAS8001 si Drop Seal

Medium Duty



Description

This fully mortised aluminium automatic drop seal features a silicone rubber gasket and internal fins. It is used to close the gap under single swing doors to maintain their acoustic, smoke and energy efficiency performance. The seal incorporates a high efficiency spring loaded mechanism that extends the seal as the door swings shut and automatically retracts it as the door is opened by just a few centimetres.

Key benefits

Effective acoustic sealing solution that is fully concealed in the bottom of the door.
 Dual internal sealing fins enhance acoustic and smoke containment performance.
 Supplied with high performance fire rated silicone rubber gasket.
 Fully automatic, no power connection required.
 Simple adjustment to suit varying door gap requirements.
 Proven long term reliability.

Approvals

Fire: Tested in accordance with AS1530.4 on proprietary AS1905.1 fire door assemblies for up to 4 hour rating.
Smoke: Tested in accordance with AS1530.7 on AS6905 compliant door assemblies. Conforms with BCA Specification C3.4 smoke sealing requirements.
Sound: Acoustically tested in accordance with ISO10140-2 and AS/NZS717.1 with ratings up to 40Rw on appropriate rated assemblies.
Durability: Long term mechanical test, completing 1,000,000 cycles without failure.

Standard lengths

435mm (may be trimmed back to 335mm)
 535mm (may be trimmed back to 435mm)
 635mm (may be trimmed back to 535mm)
 820mm (may be trimmed back to 580mm)
 920mm (may be trimmed back to 820mm)
 1070mm (may be trimmed back to 920mm)
 1220mm (may be trimmed back to 1070mm)
 1400mm (may be trimmed back to 1200mm)
 1600mm (may be trimmed back to 1400mm).

Fixing method

Fits into a 15mm wide x 35mm deep groove and retained in place with screw fixed stainless steel end plates.

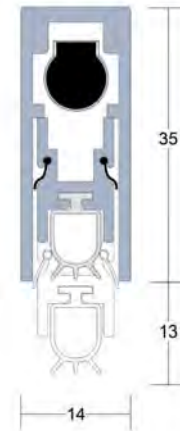

LAS8001 si



LAS8001 si drop seal (shown with LAS4002 threshold plate)

Gap sizes

Accommodates and seals gaps up to 13mm.
 Greater gaps can be sealed if product is used with a threshold plate.

Finishes

Silver anodised aluminium with stainless steel end plates and grey silicone rubber gasket.

LAS8002 si Drop Seal

Medium Duty



Description

This face-fixed (or semi-mortised) aluminium automatic drop seal features a silicone rubber gasket and internal fins. It is used to close the gap under single swing doors to maintain their acoustic, smoke and energy efficiency performance. The seal incorporates a high efficiency spring loaded mechanism that extends the seal as the door swings shut and automatically retracts it as the door is opened by just a few centimetres.

Key benefits

- Effective acoustic sealing solution that can easily be retrofitted to existing door assemblies.
- Dual internal sealing fins enhance acoustic and smoke containment performance.
- Quickly and easily fitted to the bottom of door.
- Can be fitted semi-mortised for a flush finish.
- Supplied with a fire rated silicone rubber gasket and aesthetic push-fit end caps.
- Fully automatic, no power connection required.
- Simple adjustment to suit varying door gap requirements.
- Proven long term reliability.

Approvals

- Fire:** Approved for use on proprietary AS1905.1 fire doors for up to 4 hour fire rating.
- Smoke:** Medium temperature smoke approvals for use on AS6905 compliant smoke door assemblies. Conforms with BCA Specification C3.4 smoke sealing requirements.
- Sound:** Acoustically tested in accordance with ISO10140-2 and AS/NZS717.1 with ratings up to 37Rw on appropriate rated assemblies.
- Durability:** Long term mechanical test, completing 1,000,000 cycles without failure.

Standard lengths

- 435mm (may be trimmed back to 335mm)
- 535mm (may be trimmed back to 435mm)
- 635mm (may be trimmed back to 535mm)
- 820mm (may be trimmed back to 580mm)
- 920mm (may be trimmed back to 820mm)
- 1070mm (may be trimmed back to 920mm)
- 1220mm (may be trimmed back to 1070mm)
- 1400mm (may be trimmed back to 1200mm)
- 1600mm (may be trimmed back to 1400mm).

Fixing method

- Face-fixed or semi-mortised to the bottom of the door.
- Fixing screws are supplied.

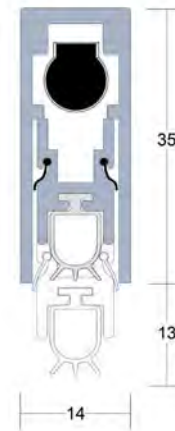

LAS8002 si

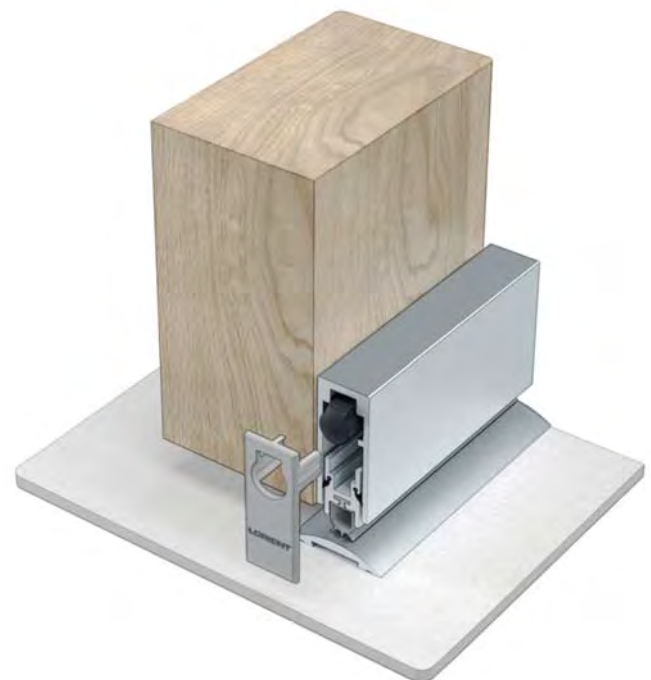

LAS8002 si drop seal (shown with LAS4002 threshold plate)

Gap sizes

- Accommodates and seals gaps up to 13mm.
- Greater gaps can be sealed if product is used with a threshold plate.

Finishes

- Silver anodised aluminium with grey push-fit end caps and grey silicone rubber gasket.

LAS8002G Drop Seal

Medium Duty



Description

This face-fixed drop seal suitable for glass doors - designed for hinged doors into timber or aluminium frames. It is non-reversible and needs to be ordered left or right handed. LAS8002G features a high efficiency mechanism which lifts the seal clear of the floor as soon as the door is opened by a few millimetres; resulting in lower door operating forces. It requires no power connection. Surface mounted application suitable for upgrading existing doors.

Key benefits

Effective acoustic sealing solution that can easily be retrofitted to existing door assemblies.
 Dual internal sealing fins enhance acoustic and smoke containment performance.
 Quickly and easily fitted to the bottom of the door.
 Supplied with a silicone rubber gasket and aesthetic push-fit end caps.
 Fully automatic, no power connection required.
 Simple adjustment to suit varying door gap requirements.
 Proven long term reliability.

Approvals

Smoke: Conforms with BCA Specification C3.4 smoke sealing requirements.

Sound: Acoustically tested in accordance with ISO10140-2 and AS/NZS717.1 with ratings up to 31Rw on appropriate rated assemblies.

Durability: Tested for reliability, the seal completed 1,000,000 cycles without failure. Suitable for various glass thicknesses from 8mm.

Standard lengths

820mm (may be trimmed back to 580mm)
 920mm (may be trimmed back to 820mm)
 1070mm (may be trimmed back to 920mm).

Fixing method

LAS8002G carrier and back plate is face-fixed with strong adhesive tape. Fit end caps. This product is non-reversible and needs to be ordered left or right handed.

Gap sizes

3mm/10mm.

Finishes

Silver anodised aluminium with grey end caps.

Grey silicone rubber.

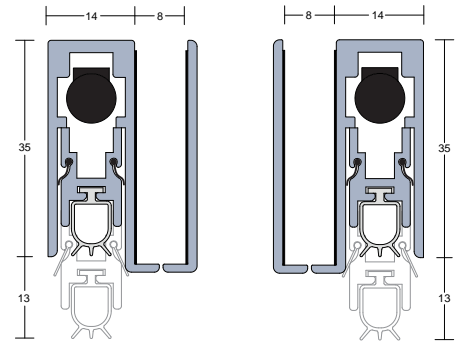

LAS8002G left handed

LAS8002G right handed

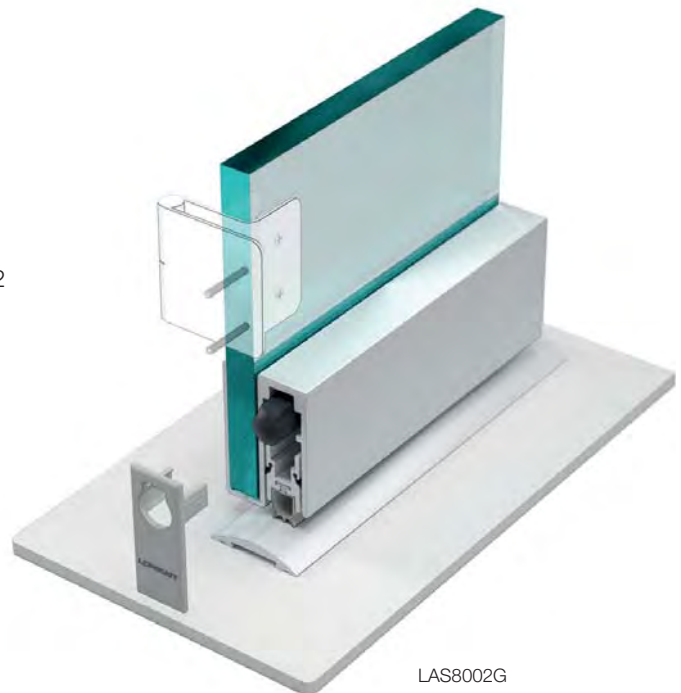

LAS8002G

LAS8003 si Drop Seal

Medium Duty



Description

This face-fixed (or semi-mortised) aluminium automatic drop seal is used to close the gap under single swing doors to maintain their acoustic, smoke and energy efficiency performance. The seal incorporates a high efficiency spring loaded mechanism that extends the seal as the door swings shut and automatically retracts it as the door is opened by just a few centimetres.

Key benefits

Effective acoustic sealing solution that can easily be retrofitted to existing door assemblies.

Dual internal sealing fins enhance acoustic and smoke containment performance.

Fixing points are fully concealed behind a click-fit cover strip.

Quickly and easily fitted to the bottom of door.

May be fitted semi-mortised for a flush finish.

Supplied with a fire rated silicone rubber gasket and colour matched push-fit end caps.

Fully automatic, no power connection required.

Simple adjustment to suit varying door gap requirements.

Proven long term reliability.

Approvals:

Fire: Approved for use on proprietary AS1905.1 fire doors for up to 4 hour fire rating.

Smoke: Medium temperature smoke approvals for use on AS6905 compliant smoke door assemblies. Conforms with BCA Specification C3.4 smoke sealing requirements.

Sound: Acoustically tested in accordance with ISO10140-2 and AS/NZS717.1 with ratings up to 37Rw on appropriate rated assemblies.

Durability: Long term mechanical test, completing 1,000,000 cycles without failure.

Standard lengths

- 435mm (may be trimmed back to 335mm)
- 535mm (may be trimmed back to 435mm)
- 635mm (may be trimmed back to 535mm)
- 820mm (may be trimmed back to 580mm)
- 920mm (may be trimmed back to 820mm)
- 1070mm (may be trimmed back to 920mm)
- 1220mm (may be trimmed back to 1070mm)
- 1400mm (may be trimmed back to 1200mm)
- 1600mm (may be trimmed back to 1400mm).

Fixing method

Face-fixed or semi-mortised to the bottom of the door.

Fixing screws are supplied.

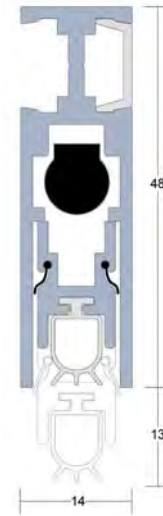

LAS8003 si



LAS8003 si drop seal (shown with LAS4002 threshold plate)

Gap sizes

Accommodates and seals gaps from 1mm to 13mm. Greater gaps can be sealed if product is used with a threshold plate.

Finishes

Silver anodised aluminium with grey push-fit end caps and grey silicone rubber gasket.

LAS8004 si Drop Seal

Medium Duty



Description

'Flat back' automatic drop seal designed for installation into hollow aluminium door bottom rails. Spring-loaded mechanism lifts the seal clear of the floor as soon as the door is opened by a few millimetres.

Key benefits

Requires no power connection.
Self-levelling on uneven floors, seal height can be adjusted independently of fixing screws.

Approvals

Durability: Tested for reliability, the seal completed 1,000,000 cycles without failure.

Standard lengths

820mm (may be trimmed back to 580mm)
920mm (may be trimmed back to 820mm)
1070mm (may be trimmed back to 920mm).

Fixing method

Fixing screws are supplied, fixing holes are pre-drilled.

Gap sizes

1mm/13mm.

Finish

Silver anodised aluminium.

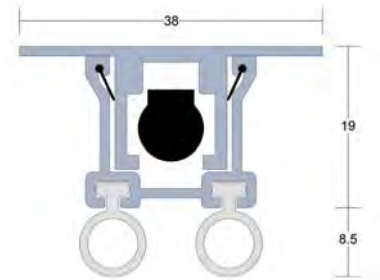

LAS8004 si

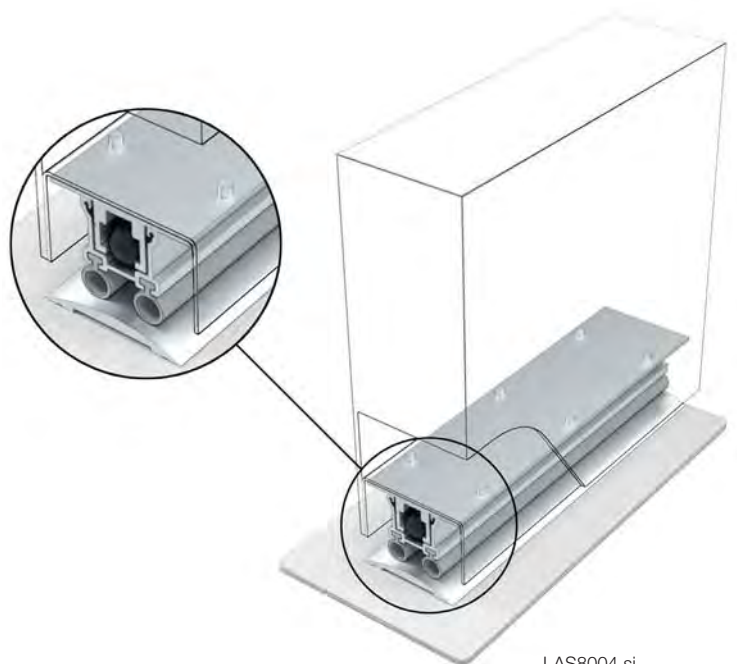

LAS8004 si
(Shown with LAS4002)

LAS8005 si Drop Seal

Medium Duty



Description

This fully mortised aluminium automatic drop seal features a silicone rubber gasket and internal fins. It is used to close the gap under single swing doors to maintain their acoustic, smoke and energy efficiency performance. The seal incorporates a high efficiency spring loaded mechanism that extends the seal as the door swings shut and automatically retracts it as the door is opened by just a few centimetres.

Key benefits

Fully concealed and mechanically fixed to the bottom of the door through the flanges.

Dual internal sealing fins enhance acoustic and smoke containment performance.

Supplied with high performance fire rated silicone rubber gasket and aesthetic colour matched end caps.

Fully automatic, no power connection required.

Simple adjustment to suit varying door gap requirements.

Proven long term reliability.

Approvals

Fire: Approved for use on proprietary AS1905.1 fire doors for up to 4 hour fire rating.

Smoke: Medium temperature smoke approvals for use on AS6905 compliant smoke door assemblies. Conforms with BCA Specification C3.4 smoke sealing requirements.

Sound: Acoustically tested in accordance with ISO10140-2 and AS/NZS717.1 with ratings up to 40Rw on appropriate rated assemblies.

Durability: Long term mechanical test, completing 1,000,000 cycles without failure.

Standard lengths

820mm (may be trimmed back to 580mm)

920mm (may be trimmed back to 820mm)

1070mm (may be trimmed back to 920mm).

Fixing method

Fits into a 15mm wide x 35mm deep groove and retained in place by screw fixing through the seal flanges.

Gap sizes

Accommodates and seals gaps up to 13mm. Greater gaps can be sealed if product is used with a threshold plate.

Finishes

Silver anodised aluminium with stainless steel end plates and grey silicone rubber gasket.

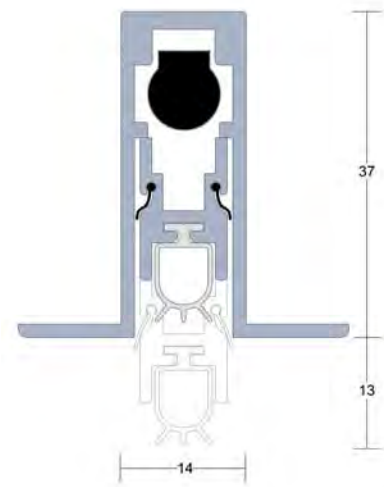

LAS8005 si



LAS8005 si drop seal (shown with LAS4002 threshold plate)

LAS8006 si Drop Seal

Heavy Duty



Description

This face-fixed (or semi-mortised) aluminium automatic drop seal features a silicone rubber gasket and internal fins. It is used to close the gap under single swing doors to maintain their acoustic, smoke and energy efficiency performance. The seal incorporates a high efficiency spring loaded mechanism that extends the seal as the door swings shut and automatically retracts it as the door is opened by just a few centimetres.

Key benefits

- Effective acoustic sealing solution that can easily be retrofitted to existing door assemblies.
- Dual internal sealing fins enhance acoustic and smoke containment performance.
- Quickly and easily fitted to the bottom of door.
- Can be fitted semi-mortised for a flush finish.
- Supplied with a fire rated silicone rubber gasket and aesthetic push-fit end caps.
- Fully automatic, no power connection required.
- Simple adjustment to suit varying door gap requirements.
- Proven long term reliability.

Approvals

- Fire:** Tested in accordance with AS1530.4 on proprietary AS1905.1 fire door assemblies for up to 4 hour rating.
- Smoke:** Medium temperature smoke approvals for use on AS6905 compliant smoke door assemblies. Conforms with BCA Specification C3.4 smoke sealing requirements.
- Sound:** Acoustically tested in accordance with ISO10140-2 and AS/NZS717.1 with ratings up to 40Rw on appropriate rated assemblies.
- Durability:** Long term mechanical test, completing 1,000,000 cycles without failure.

Standard lengths

- 435mm (may be trimmed back to 335mm)
- 820mm (may be trimmed back to 720mm)
- 920mm (may be trimmed back to 820mm)
- 1070mm (may be trimmed back to 920mm)
- 1220mm (may be trimmed back to 1070mm)
- 1400mm (may be trimmed back to 1200mm)
- 1600mm (may be trimmed back to 1400mm).

Fixing method

- Face-fixed or semi-mortised to the bottom of the door.
- Fixing screws are supplied.

Gap sizes

- Accommodates and seals gaps from up to 13mm. Greater gaps can be sealed if product is used with a threshold plate.

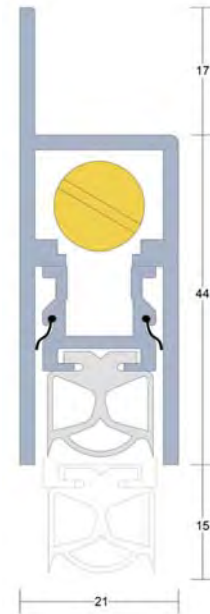

LAS8006 si

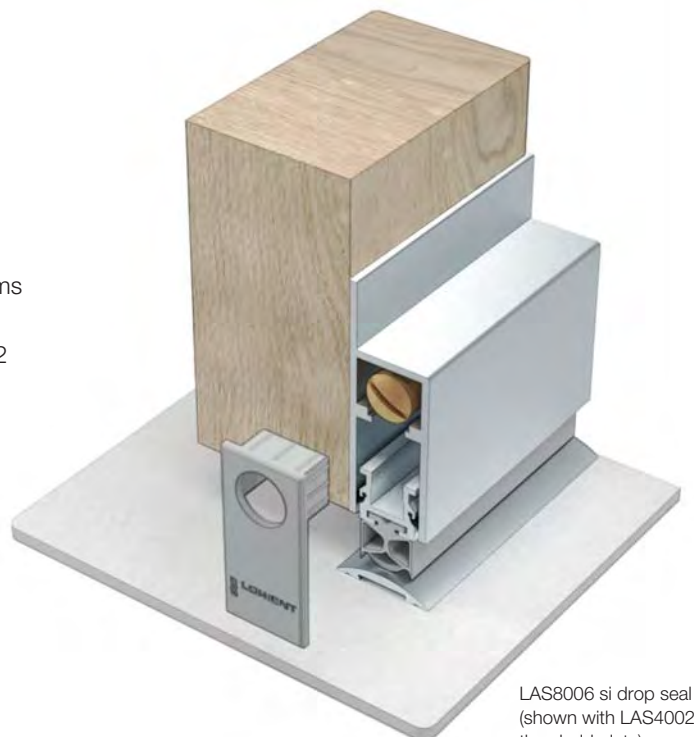

LAS8006 si drop seal (shown with LAS4002 threshold plate)

Gap sizes

- Accommodates and seals gaps up to 13mm.
- Greater gaps can be sealed if product is used with a threshold plate.

Finishes

- Silver anodised aluminium with grey push-fit end caps and grey silicone rubber gasket.

LAS8007 si Drop Seal

Heavy Duty



Description

This heavy duty fully mortised aluminium automatic drop seal features a silicone rubber gasket and internal fins. It is used to close the gap under single swing doors to maintain the acoustic, smoke and energy efficiency performance. The seal incorporates a high efficiency spring loaded mechanism that extends the seal as the door swings shut and automatically retracts it as the door is opened by just a few centimetres.

Key benefits

- Dual internal sealing fins enhance acoustic and smoke containment performance.
- Supplied with high performance fire rated silicone rubber gasket.
- Fully automatic, no power connection required.
- Simple adjustment to suit varying door gap requirements.
- Proven long term reliability.

Approvals

- Fire:** Approved for use on proprietary AS1905.1 fire doors for up to 4 hour fire rating.
- Smoke:** Medium temperature smoke approvals for use on AS6905 compliant smoke door assemblies. Conforms with BCA Specification C3.4 smoke sealing requirements.
- Sound:** Acoustically tested in accordance with ISO10140-2 and AS/NZS717.1 with ratings up to 40Rw on appropriate rated assemblies.
- Durability:** Long term mechanical test, completing 1,000,000 cycles without failure.

Standard lengths

- 820mm (may be trimmed back to 720mm)
- 920mm (may be trimmed back to 820mm)
- 1070mm (may be trimmed back to 920mm).

Fixing method

Fixing screws are supplied, fixing holes are pre-drilled through the flanges.

Gap sizes

Up to 15mm.

Finishes

Silver anodised aluminium, grey silicone rubber gasket, grey end caps.

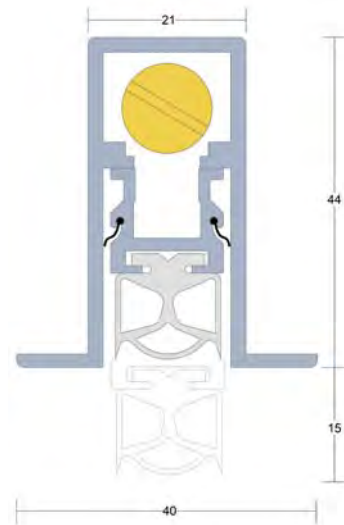

LAS8007 si



LAS8007 si drop seal (Shown with LAS4002 threshold plate)

LAS8008 si Drop Seal

Medium Duty



Description

A face fixed drop seal with a smooth aesthetic curved cover that incorporates a high efficiency mechanism which lifts the seal clear of the floor as soon as the door is opened by a few millimetres; resulting in lower door operating forces. Its curved cover plate provides enhanced aesthetics: surface mounted only.

Key benefits

Effective acoustic sealing solution that can easily be retrofitted to existing door assemblies.
Durable flexible elastomeric fin elements are incorporated with the housing to provide acoustic and smoke properties. It requires no power connection.
Curved cover conceals fixing points.
Surface mounted application suitable for upgrading existing doors.
Proven long term reliability.

Approvals

Fire: Approved for use on proprietary AS1905.1 fire doors for up to 4 hour fire rating.
Smoke: Medium temperature smoke approvals for use on AS6905 compliant smoke door assemblies. Conforms with BCA Specification C3.4 smoke sealing requirements.
Sound: Acoustically tested in accordance with ISO10140-2 and AS/NZS717.1 with ratings up to 40Rw on appropriate rated assemblies.
Durability: Long term mechanical test, completing 1,000,000 cycles without failure.

Standard lengths

820mm (may be trimmed back to 580mm)
920mm (may be trimmed back to 820mm)
1070mm (may be trimmed back to 920mm).

Fixing method

Fixing screws are supplied, holes should be drilled at time of fixing. LAS8008 si is surface mounted only.

Gap sizes

Accommodates and seals gaps up to 13mm. Greater gaps can be sealed if product is used with a threshold plate.

Finishes

Silver anodised aluminium with grey plastic end caps.
Grey silicone rubber. Special colours can be supplied using a powder coated finish for additional aesthetics.

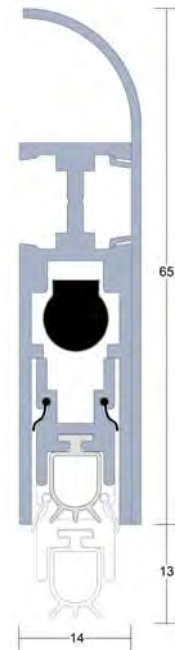

LAS8008 si



LAS8008 si drop seal
(Shown with LAS4002
threshold plate)

LAS8009 si Drop Seal

Heavy Duty



Description

A heavy duty automatic drop seal which incorporates a smooth aesthetic curved cover and spring-loaded mechanism which lifts clear of the floor as soon as the door is opened by a few millimetres. Plastic end caps are supplied.

Key benefits

Effective acoustic sealing solution that can easily be retrofitted to existing door assemblies.
 Dual internal sealing fins enhance acoustic and smoke containment performance.
 Quickly and easily fitted to the bottom of door.
 Can be fitted semi-mortised for a flush finish.
 Supplied with a fire rated silicone rubber gasket and aesthetic push-fit end caps.
 Fully automatic, no power connection required.
 Simple adjustment to suit varying door gap requirements.
 Proven long term reliability.

Approvals

Fire: Approved for use on proprietary AS1905.1 fire doors for up to 4 hour fire rating.
Smoke: Medium temperature smoke approvals for use on AS6905 compliant smoke door assemblies. Conforms with BCA Specification C3.4 smoke sealing requirements.
Sound: Acoustically tested in accordance with ISO10140-2 and AS/NZS717.1 with ratings up to 40Rw on appropriate rated assemblies.
Durability: Long term mechanical test, completing 1,000,000 cycles without failure.

Standard lengths

820mm (may be trimmed back to 720mm)
 920mm (may be trimmed back to 820mm)
 1070mm (may be trimmed back to 920mm).

Fixing method

Fixing screws are supplied, holes should be drilled at time of fixing.

Gap sizes

Up to 15mm.

Finishes

Silver anodised aluminium cover plate, grey silicone rubber gasket, grey end caps.
 Special colours can be supplied using a powder coated finish for additional aesthetics.

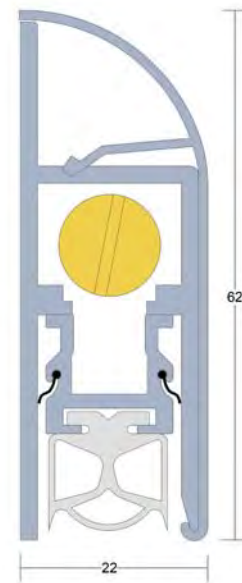

LAS8009 si

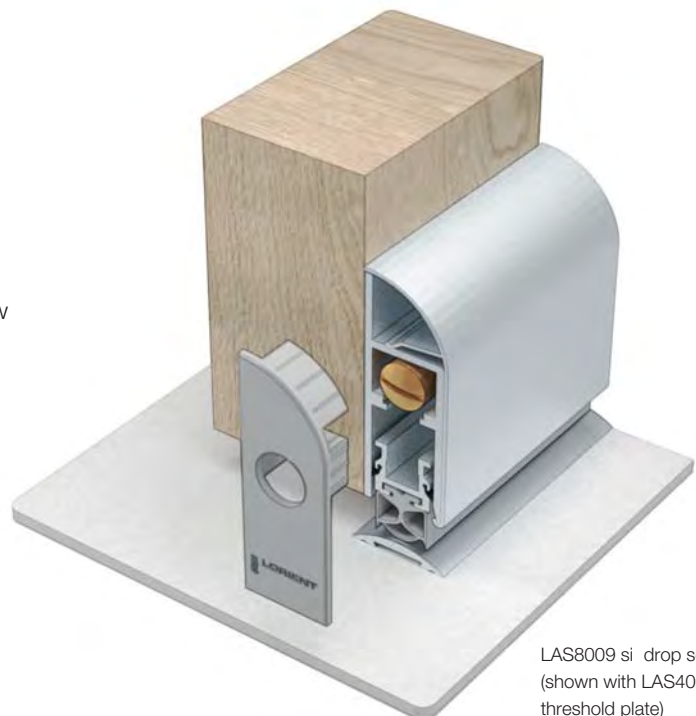

LAS8009 si drop seal (shown with LAS4002 threshold plate)

LAS3001 si, LAS3002 si, LAS3003 si & LAS3009 si Door Bottom Seals

Medium Duty



Description

Door bottom and meeting stile seals ideal for acoustic and smoke containment.

Key benefits

Simple, effective sealing solution.
Easily retrofitted to existing door assemblies.
Durable, hard wearing silicone rubber gaskets.

Approvals

Smoke: Conforms with BCA Specification C3.4 smoke sealing requirements.

Durability: Long term mechanical test, completing 1,000,000 cycles without failure.

Standard lengths

1m and 2.1m. Other lengths to special order.

Gap sizes

LAS3001 si – 6mm/13mm.

LAS3002 si – 10mm/17mm.

LAS3003 si – 7mm/13mm.

LAS3009 si – 12mm/18mm.

Fixing method

Face-fixed, semi-rebated or fully rebated.
Fixing screws are supplied.
Fixing holes are pre-drilled.
Once the aluminium carrier is fixed, the rubber gasket slides easily into place.
Note: these seals cannot be adjusted once fitted.

Finishes

Silver anodised aluminium with grey silicone rubber insert.

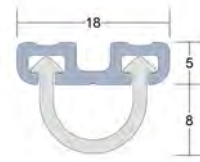

LAS3001 si

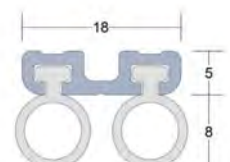

LAS3003 si

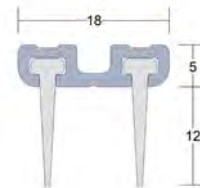

LAS3002 si

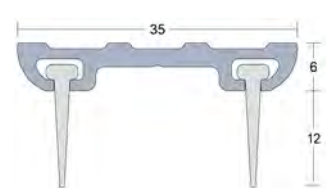

LAS3009 si



LAS3001 si door bottom seal (shown with LAS4002 threshold plate)

LAS3004 si Door Bottom Seal

Heavy Duty



■ Description

A heavy duty sweep action door bottom seal.

■ Key benefits

- Hard wearing and durable seal.
- Slim-line, aesthetic design.
- Seal screw-fixed.
- Suitable for BAL 40, BAL FZ Bushfire sealing requirements.

■ Approvals

- Fire:** Approved for use on proprietary AS1905.1 fire doors for up to 4 hour fire rating.
- Smoke:** Conforms with BCA Specification C3.4 smoke sealing requirements.
- Durability:** Long term mechanical test, completing 1,000,000 cycles without failure.

■ Standard lengths

1m and 2.1m. Other lengths to special order.

■ Fixing method

- Fixing screws supplied.
- Fixing holes are pre-drilled and slotted to allow the seals to be adjusted and positioned accurately.

■ Gap sizes

10mm/22mm.

■ Finishes

- Silver anodised aluminium with grey cover strip and grey silicone rubber blade.

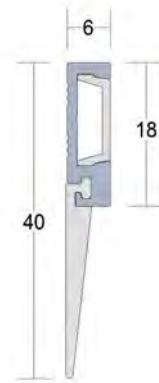

LAS3004 si



LAS3004 si door bottom (shown with LAS4010 threshold plate)

LAS3007 si Door Bottom Seal

Heavy Duty



Description

A weather proof seal which can be fitted without removing the door, and can be used with a choice of threshold plates.

Key benefits

Durable multi-bladed silicone seal.
 Snap-fit cover strip conceals fixing points.
 Slotted fixing holes provide simple adjustment.
 Aesthetic anodised finish.

Approvals

Smoke: Conforms with BCA Specification C3.4 smoke sealing requirements.

Durability: Long term mechanical test, completing 1,000,000 cycles without failure.

Standard lengths

1m and 2.1m. Other lengths to special order.

Fixing method

Self-tapping screws are supplied. Fixing holes are pre-drilled and slotted to allow the seals to be adjusted and positioned accurately. A snap-fit cover strip to conceal fixings is supplied.

Gap sizes

12mm/14mm.

Finishes

Silver anodised aluminium with grey cover strip and grey silicone rubber gasket.

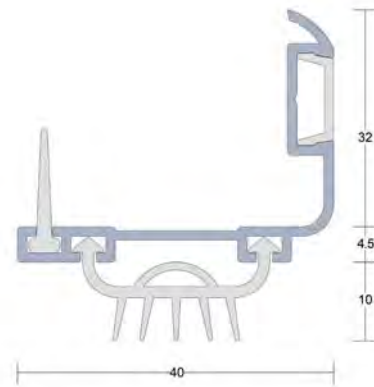

LAS3007 si



LAS3007 si door bottom (shown with LAS4015 threshold plate, also referred to as LAS3008 si- full set is referenced as LAS3008 si)

LAS4002 Threshold Plate

Medium Duty

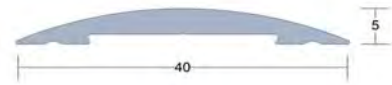

LAS4002

Description

Used where the door sill is uneven, this threshold plate creates a level sealing surface that greatly enhances the ability of door bottom seals to restrict the passage of sound, smoke, energy or weather.

Key benefits

- Creates a flat sealing surface.
- Enhances the performance of other sealing systems.
- Slim-line geometry satisfies AS1428.1 access for people with disability requirements.
- Durable hard wearing anodised finish.

Approvals

Fire: Approved for use on proprietary AS1905.1 fire doors for up to 4 hour fire rating.

Smoke: Tested in accordance with AS1530.7 on AS6905 compliant door assemblies.

Sound: Acoustically tested as part of a system in accordance with ISO10140-2 and AS/NZS717.1.

Standard lengths

1m and 2.1m. Other lengths available to special order.

Fixing method

Mechanically fixed to threshold with supplied screw pack or adhered with construction adhesive.

Gap sizes

Minimum 6mm door undercut.

Finishes

Silver anodised aluminium.

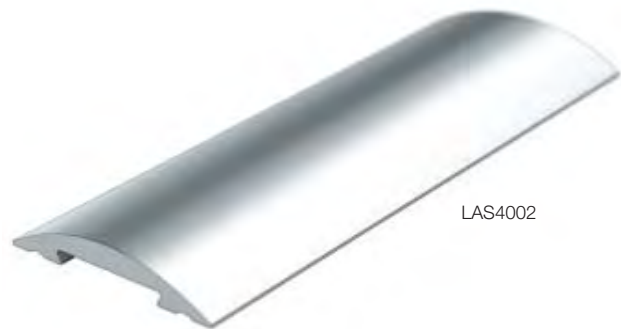

LAS4002



LAS8001 si drop seal (shown in conjunction with LAS4002 threshold plate)

LAS4010, LAS4011, LAS4012 & LAS4013 Threshold Plates

Medium Duty



Description

Low profile threshold plates, only 6mm high. These plates, when used in conjunction with threshold (door bottom) seals prevent rain, draught, and smoke penetration.

Key benefits

These plates, when used in conjunction with threshold (door bottom) seals prevent rain, draught, and smoke penetration.

Approvals

Fire: Approved for use on proprietary AS1905.1 fire door assemblies for up to 4 hour fire rating.

Standard lengths

1m, 2.1m and 3m. Other lengths to special order.

Fixing method

Fixing screws are supplied.

Finishes

Silver anodised aluminium.



LAS4010



LAS4010

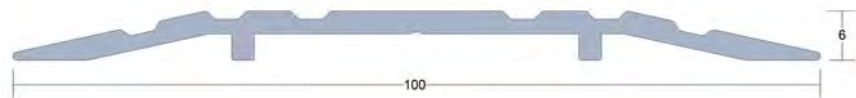

LAS4011



LAS4012

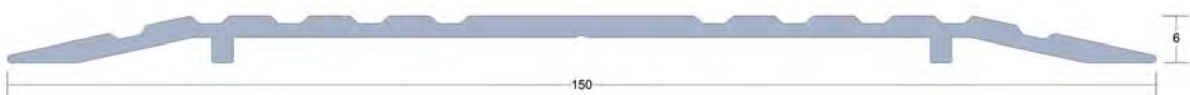

LAS4013

LAS4014 si Threshold Plate

Heavy Duty



■ Description

Heavy duty threshold plate suitable for outward opening doors to prevent rain, draught, light and noise penetration.

■ Key benefits

Durable anodised aesthetic finish.
High performance silicone compression seal helps resist rain, light, dust and noise penetration.

■ Approvals

Sound: Acoustically tested in accordance with ISO10140-2 and AS/NZS717.1.

Fire: Approved for use on proprietary AS1905.1 fire door assemblies for up to 4 hour fire rating.

■ Standard lengths

1m and 2.1m. Other lengths to special order.

■ Fixing method

Fixing screws are supplied.

■ Finishes

Silver anodised aluminium with grey silicone rubber gasket.



LAS4014 si

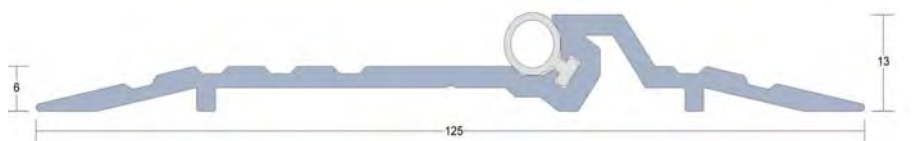

LAS4014 si

LAS4015 si Threshold Plate

Heavy Duty

■ **Description**

Suitable for outward opening doors to prevent rain.

■ **Key benefit**

Durable anodised aesthetic finish.

■ **Approvals**

Fire: Approved for use on proprietary AS1905.1 fire door assemblies for up to 4 hour fire rating.

■ **Standard lengths**

1m and 2.1m. Other lengths to special order.

■ **Fixing method**

Fixing screws are supplied.

■ **Finishes**

Silver anodised aluminium with grey cover strip.



LAS4015 si



LAS4015 si

LAS5010, LAS5015, LAS5020, LAS5025 & LAS5030 Brush Seals

Medium Duty



Description

Medium duty brush seals, suitable for numerous installation and door types. Suitable for sealing garage doors as per AS3959 Bushfire standard.

Key benefits

Can be used with any threshold plate.

Approvals

Durability: Long term mechanical test, completing 1,000,000 cycles without failure.

Standard lengths

1m and 2.1m.

Seals may be butt jointed together for extended runs.

Gap sizes

LAS5010: 10mm/13mm.

LAS5015: 13mm/19mm (non-stock item).

LAS5020: 19mm/25mm.

LAS5025: 25mm/35mm.

LAS5030: 35mm/45mm.

Fixing method

Heavy duty self-adhesive tape and supplied screw pack.

Finishes

Silver anodised aluminium with black brush filaments.

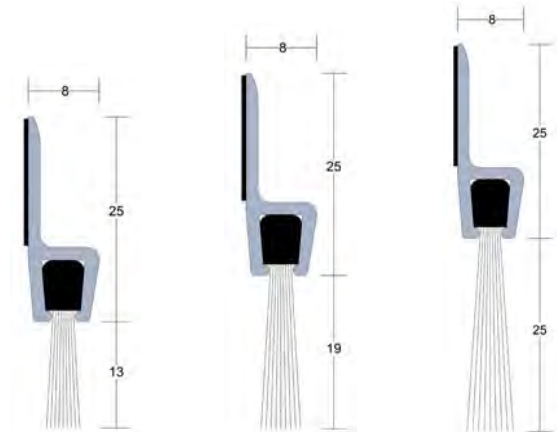

LAS5010

LAS5015

LAS5020

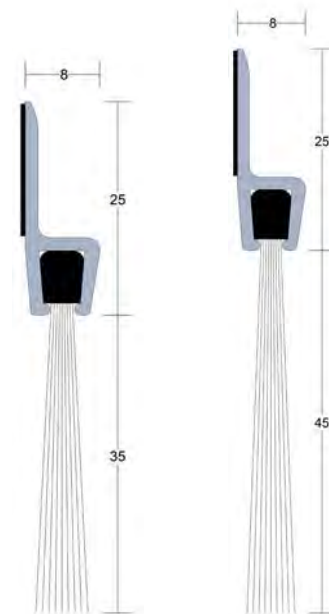

LAS5025

LAS5030

Brush Seals

LAS5035, LAS5040, LAS5045, LAS5050 & LAS5055 Brush Seals

Heavy Duty



Description

Hard-wearing, heavy duty brush seals for use with larger gap sizes and more challenging applications. Suitable for sealing garage doors as per AS3959 Bushfire standard.

Key benefits

Can be used with any threshold plate.
Suitable for garage doors as detailed in AS3959.
Filaments retained in anodised aluminium carrier.

Approvals

Durability: Long term mechanical test, completing 1,000,000 cycles without failure.

Standard lengths

1m and 2.1m.
Seals may be butt jointed together for extended runs.

Fixing method

Heavy duty self-adhesive tape and supplied screw pack.

Gap sizes

LAS5035: 20mm/40mm.
LAS5040: 40mm/60mm.
LAS5045: 60mm/80mm.
LAS5050: 80mm/120mm.
LAS5055: 120mm/150mm.

Finishes

Silver anodised aluminium with black brush filaments.

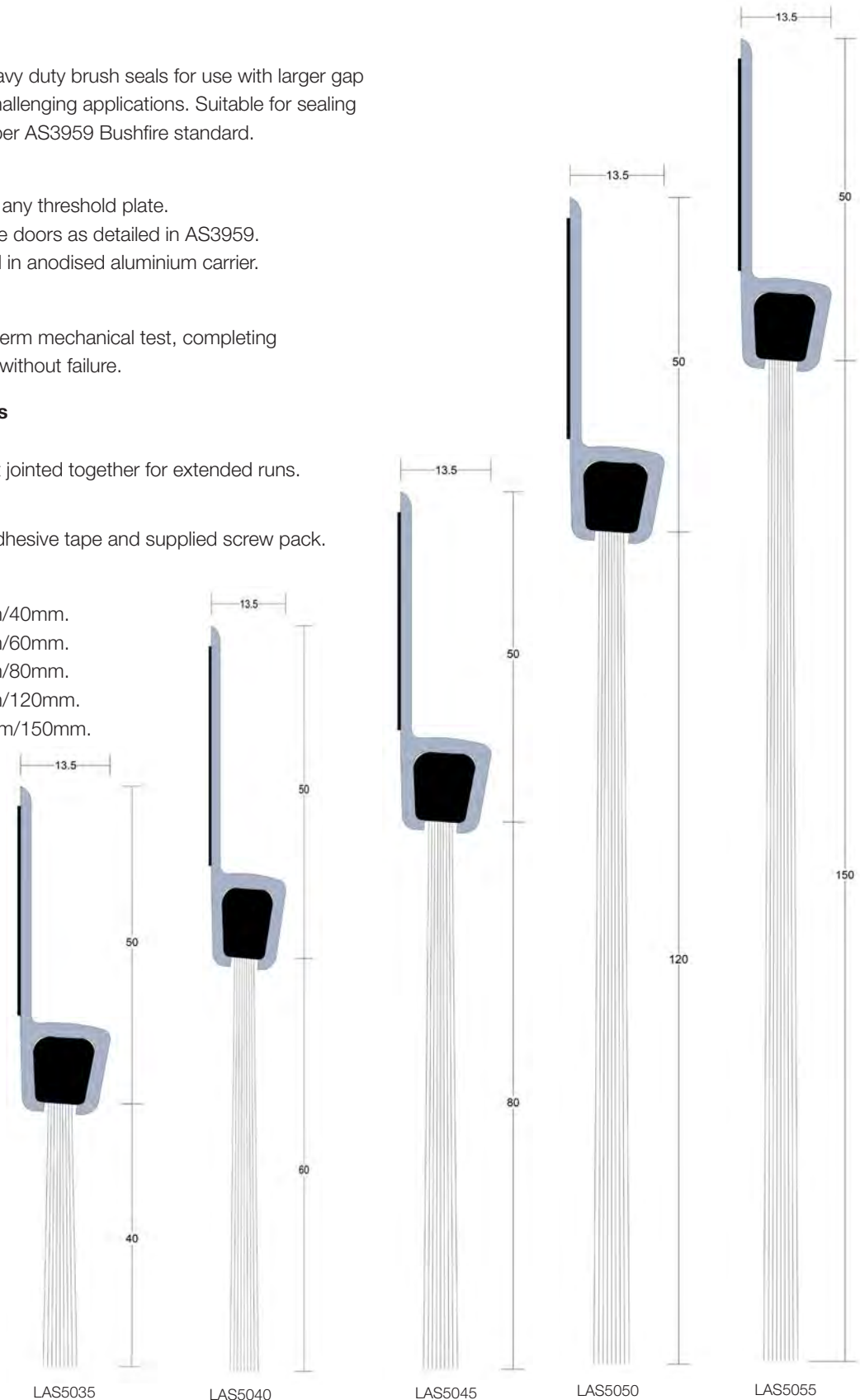

LAS5060, LAS5065 & LAS5070 Brush Seals

Medium Duty



Description

Medium duty brushes with right angled carriers, offered with a choice of three brush lengths. Suitable for sealing garage doors as per AS3959 Bushfire standard.

Key benefits

Filaments retained in anodised aluminium carrier.
Low friction filaments flex and conform to uneven surfaces.
Durable, effective sealing solution.

Approvals

Durability: Long term mechanical test, completing 1,000,000 cycles without failure.

Standard lengths

1m and 2.1m.
Seals may be butt jointed together for extended runs.

Fixing method

Heavy duty self-adhesive tape and supplied screw pack.

Gap sizes

LAS5060: 24mm/30mm.
LAS5065: 32mm/40mm.
LAS5070: 39mm/50mm.

Finishes

Silver anodised aluminium with black brush filaments.

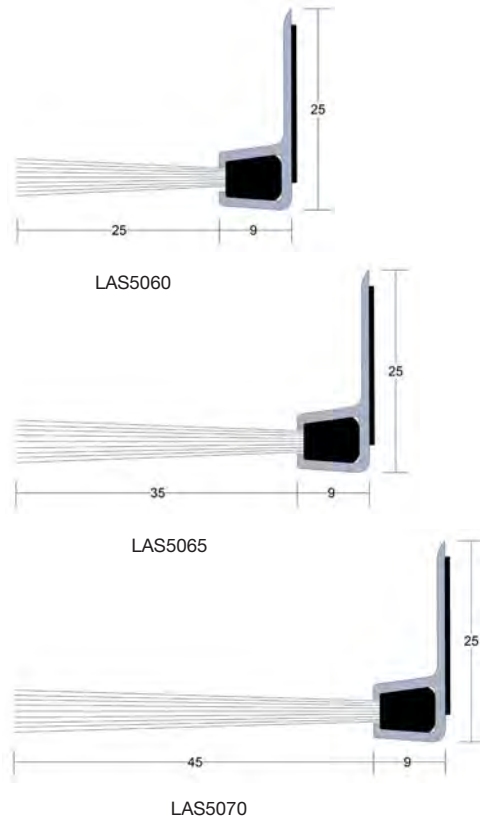

LAS5075, LAS5080 & LAS5085 Brush Seals

Medium Duty



Description

Medium duty brushes with angled carriers, offered with a choice of three brush lengths. Suitable for sealing garage doors as per AS3959 Bushfire standard.

Key benefits

Filaments retained in anodised aluminium carrier. Low friction filaments flex and conform to uneven surfaces. Durable, effective sealing solution.

Approvals

Durability: Long term mechanical test, completing 1,000,000 cycles without failure.

Standard lengths

1m and 2.1m.

Seals may be butt jointed together for extended runs.

Fixing method

Heavy duty self-adhesive tape and supplied screw pack.

Gap sizes

LAS5075: 20mm/40mm. LAS5040: 40mm/60mm.

LAS5080: 60mm/80mm. LAS5050: 80mm/120mm.

LAS5085: 120mm/150mm.

Finish

Silver anodised aluminium with black brush filaments.



LAS9050 & LAS9070 Hingeguard and Fingerguard Seals

Medium Duty

Description

Trapping fingers in hinged doors can cause horrendous injuries. The risk is especially high in locations where young children are present. The finger guard seals provide a deterrent barrier that shields both sides of the hinged door jamb.

Key benefits

Protection may be provided by using the LAS9050 on the hinge knuckle side and the LAS9070 to the reveal side.

LAS9070 includes unique, integral acoustic sealing fins and may be used in conjunction with the LAS7001 si and LAS8001 si to create a comprehensive acoustic sealing and finger protection system.

Approvals

Durability: Tested over 200,000 full opening and closing cycles without any sign of degradation.

Standard lengths

2.1m. Other lengths to special order.
Single doorset packs are available containing 1 x 2.1m LAS9050 and 1 x 2.1m LAS9070.

Fixing method

Fixing screws are supplied. Fixing holes are pre-drilled and slotted to allow the seals to be adjusted and positioned accurately. A PVC cover strip to conceal fixings is supplied.

Finishes

Supplied with black gasket and grey cover strip.

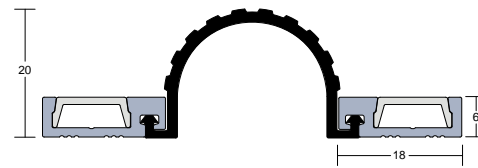

LAS9050 Hingeguard

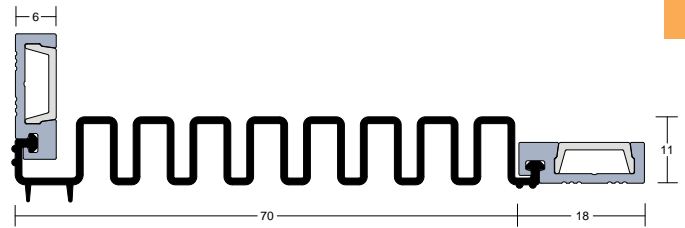

LAS9070 Fingerguard



LAS9050 Hingeguard and LAS9070 Fingerguard

LAS1812 LSS Intumescent Fire and Smoke Seal

Medium Duty

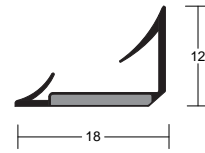

LAS1812 LSS

Description

This slim-line, dual function life safety seal is fitted to door frames to restrict the spread of ambient and elevated temperature smoke. When exposed to fire conditions the intumescent core rapidly expands in volume to restrict the passage of hot smoke and toxic gases.

Key benefits

All-in-one “life safety” seal. Ideal for use in fire engineering solutions to limit the spread of fire, ambient, medium and hot temperature smoke around the edges of doors.

Easily retrofitted to existing door assemblies.

Dual sealing fins accommodate significant door deflection to maintain effective sealing performance.

Dual low friction curved elastomeric fins provide outstanding acoustic performance.

Discreetly positioned in frame rebate to provide a fully concealed sealing solution.

Simple peel-and-stick installation, our aggressive self-adhesive backing is tested on many surfaces to ensure seal longevity.

Seal surface and fins contain anti-microbial additives to restrict bacterial growth.

Combine with LAS8001 si for complete “life safety door” sealing solution.

Approvals

Fire: Approved for use on proprietary AS1905.1 fire door assemblies for up to 4 hour fire rating.

Smoke: AS1530.7 smoke test data on AS6905 compliant smoke door assemblies.

Sound: Acoustically tested in accordance with ISO10140-2 and AS/NZS717.1 with ratings up to Rw39 on appropriate rated assemblies.

Durability: Long term mechanical test, completing 1,000,000 cycles without failure.

Standard lengths

1m, 2.1m and 2.75m.

Single doorset pack (SDP): (1 x 1m, 2 x 2.1m)

Long single doorset pack (LSDP): (1 x 1m, 2 x 2.75m)

Double doorset pack (DDP): (3 x 2.1m)

Long double doorset pack (LDDP): (1 x 2.1m, 2 x 2.75m).

Fixing method

Aggressive film backed self-adhesive.

Gap sizes

3mm.

Finishes

Standard colour: Black with black fins. White, brown available to special order.



LAS1812 LSS

LAS400TF Fire and Smoke Seal for Steel Door Frames

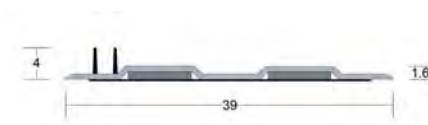

LAS400TF

■ Description

This slim high performance intumescent fire and smoke seal is designed to upgrade existing door assemblies that are required to restrict the passage of medium and hot temperature smoke. The dual flexible fins retard the spread of smoke and when exposed to elevated temperatures the intumescent core rapidly expands in volume to restrict the passage of fire, hot smoke and toxic gases.

■ Key benefits

Slim-line retrofit fire and smoke upgrade solution.
Simple peel-and-stick installation, our aggressive self-adhesive backing is tested on many surfaces to ensure seal longevity.
Ideal for use in fire engineering solutions to limit the spread of smoke and hot gasses around the edges of doors.
Seal surface and fins contain anti-microbial additives to restrict bacterial growth.
Combine with LAS8001 si for complete “life safety door” sealing solution.

■ Approvals

Fire: Tested in accordance with AS1530.4 on proprietary AS1905.1 fire door assemblies for up to 4 hour rating.

■ Standard lengths

1m, 2.1m and 2.75m.

■ Fixing method

Aggressive film backed self-adhesive.

■ Gap sizes

3mm.

■ Finish

White.



LAS400TF

LAS1602BB Intumescent Fire and Smoke Seal



Description

This slim-line, dual function seal is fitted to door frames to restrict the spread of ambient and elevated temperature smoke. When exposed to fire conditions the intumescent core rapidly expands in volume to restrict the passage of hot smoke and toxic gases.

Key benefits

All-in-one “life safety” seal. Ideal for use in fire engineering solutions to limit the spread of fire and smoke around the edges of doors.

Easily retrofitted to existing door assemblies, electrical cupboards, or access panels.

Low profile elastomeric bubble provides additional acoustic performance.

Discretely positioned in frame rebate to provide a fully concealed sealing solution.

Simple peel-and-stick installation, our aggressive self-adhesive backing is tested on many surfaced to ensure seal longevity.

Seal surface contains anti-microbial additives to restrict bacterial growth.

Combine with LAS8001 si for complete “life safety door” sealing solution.

Approval

Fire: Approved for use on proprietary AS1905.1 fire door assemblies for up to 4 hour fire rating.

Standard lengths

2.1m lengths available.

Fixing method

Aggressive film backed self-adhesive.

Gap size

3mm.

Finish

Standard colour: Black.



LAS1602BB

LAS1602 Intumescent Fire and Hot Smoke Seal

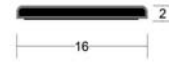

LAS1602

ANTIMICROBIAL
PROTECTION

■ Description

This slim flexible intumescent fire seal is fitted to door frames to enhance their fire resistance characteristics. When exposed to elevated temperatures the intumescent core rapidly expands in volume to restrict the passage of fire, hot smoke and toxic gases.

■ Key benefits

Ideal for use in fire engineering solutions to enhance fire performance and limit the spread of hot gases around the edges of doors.

Easily retrofitted to existing door assemblies.

Simple peel-and-stick installation, our aggressive self-adhesive backing is tested on many surfaces to ensure seal longevity.

Supplied in standard length coils to minimise on-site wastage.

Seal surface contains anti-microbial additives to restrict bacterial growth.

Use in conjunction with a LAS1212 Batwing® seal and LAS8001 si drop seal for a complete “life safety door” sealing solution.

■ Approval

Fire: Approved for use on proprietary AS1905.1 fire door assemblies for up to 4 hour fire rating.

■ Standard lengths

75m coils.

■ Fixing method

Aggressive film backed self-adhesive.

■ Gap sizes

2.5mm - 3mm.

■ Finish

Standard colour: Black.



LAS1602

LAS1202 Intumescent Fire and Hot Smoke Seal

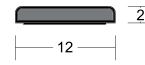

LAS1202

■ Description

This slim flexible intumescent fire seal is fitted to door frames to enhance their fire resistance characteristics. When exposed to elevated temperatures the intumescent core rapidly expands in volume to restrict the passage of fire, hot smoke and toxic gases.

■ Key benefits

Ideal for use in fire engineering solutions to enhance fire performance and limit the spread of hot gases around the edges of doors.

Easily retrofitted to existing door assemblies.

Simple peel-and-stick installation, our aggressive self-adhesive backing is tested on many surfaces to ensure seal longevity.

Supplied in standard length coils to minimise on-site wastage.

Seal surface contains anti-microbial additives to restrict bacterial growth.

■ Approval

Fire: AS1530.4 fire approvals on proprietary fire door assemblies.

■ Standard lengths

75m coils.

■ Fixing method

Aggressive film backed self-adhesive.

■ Gap sizes

2.5mm - 3mm.

■ Finish

Standard colour: Black.



LAS1202

LP1004, LP1504 and LP2004 Intumescent Fire Seals



Description

These cased intumescent strips are fitted into the door edge or timber frame to restrict the spread of fire and hot smoke. When exposed to fire conditions the intumescent core rapidly expands in volume to restrict the passage of hot smoke and toxic gases.

Key benefits

Ideal for use in fire engineering solutions to limit the spread of fire and hot smoke around the edges of doors. May be used to improve fire performance of existing door assemblies.

Seal casing contains anti-microbial additives to restrict bacterial growth.

Use in conjunction with a LAS1212 Batwing® seal and LAS8001 si drop seal for a complete “life safety door” sealing solution.

Approvals

Fire: AS1530.4 fire approvals on proprietary fire door assemblies.

Durability: rigid casing protects the intumescent core ensuring service longevity.

Standard lengths

1m and 2.1m.

Fixing method

The product fits into a groove made in the door frame and or the edge of the door leaf and is secured using the integral self-adhesive tape.

Finishes

Standard colours: Black, white or brown.

Many more colours available.

LP Series



Code

LP1004

Width x Depth

10mm x 4mm



LP1504

15mm x 4mm



LP2004

20mm x 4mm



A typical installation for life safety incorporating a LP1504 fire seal, LAS1212 smoke seal on a timber frame and LAS8001 si drop seal.

LP1004DS, LP1504DS & LP2004DS Intumescent Acoustic, Smoke and Fire Seals



Description

This acoustic, smoke and fire seal is designed to allow seal continuity at hinge positions. This slim-line seal is fitted into the door edge or timber frame to restrict the spread of ambient and elevated temperature smoke. When exposed to fire conditions the high performance intumescent core rapidly expands in volume to seal the door perimeter and restrict the passage of fire, toxic gases and hot smoke.

Key benefits

All-in-one “life safety” seal. Ideal for use in fire engineering solutions to limit the spread of fire and smoke around the edges of doors.

May be used to improve fire resistance performance of existing door assemblies.

Low friction elastomeric fins provide excellent acoustic and smoke containment performance as well as contributing to low operating forces.

Intumescent core protected by a durable thermoplastic sheath.

Suitable for healthcare applications, the casing and fins feature anti-microbial additives to limit bacterial growth.

Use in conjunction with a LAS8001 si drop seal for complete “life safety door” sealing solution.

Approvals

Fire: AS1530.4 fire approvals on proprietary fire door assemblies.

Sound: Acoustically tested in accordance with ISO10140-2 and AS/NZS717.1 with ratings up to 35Rw on appropriate rated assemblies.

Durability: Tested for reliability, seals completed 1,000,000 cycles without failure.

Standard lengths

1m and 2.1m.

Fixing method

The product fits into a groove made in the door frame or the edge of the door leaf and is secured using the self-adhesive tape backing.

Gap sizes

2.5mm - 3mm.

Finishes

Standard colour: Black with black fins.

Many more colours available.

LP-DS Series

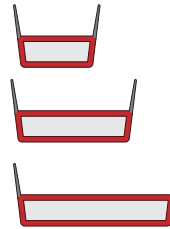

Code

LP1004DS

LP1504DS

LP2004DS

Width x Depth

10mm x 4mm

15mm x 4mm

20mm x 4mm



LDBU Lorient Door Bottom Upgrade



■ Description

This retro-fit seal is used to upgrade fire door assemblies that have a door bottom clearance that exceeds the 10mm specified in AS1905.1

■ Key benefits

Simple screw fix installation.

Suitable for upgrading door bottom gaps up to *24mm.
Cost savings for building owners as non-compliant fire door assemblies may be simply salvaged rather than replaced.

Incorporates a waterproof high performance intumescent strip suitable for exterior applications.

Durable silicone rubber gaskets.

■ Approvals

Fire: Tested in accordance with AS1530.4 on proprietary AS1905.1 fire door assemblies for up to 4 hour rating.

■ Standard lengths

820mm, 920mm and 1220mm.

■ Fixing method

Screw fixed to door bottom.

■ Gap sizes

11mm - 24mm*. **please refer to our technical brochure "Retro-fit Sealing Solutions for Non-compliant Fire Door Assemblies" regarding maximum allowable gap sizes.*

■ Finish

Silver anodised aluminium with grey gasket.

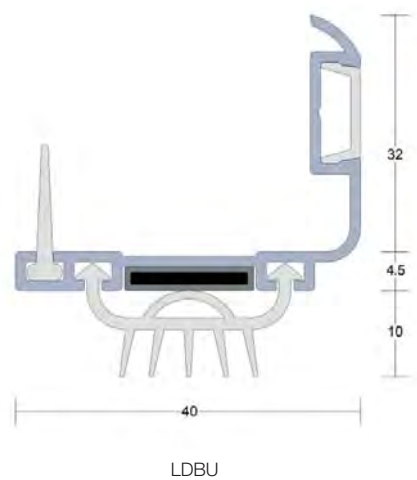

LDPU Lorient Door Perimeter Upgrade

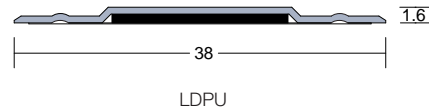

■ Description

This slim high performance intumescent fire seal is used to upgrade fire door assemblies that have perimeter clearances exceeding the 3mm specified in AS1905.1. When exposed to elevated temperatures the intumescent core rapidly expands in volume to restrict the passage of fire, hot smoke and toxic gases.

■ Key benefits

Simple peel-and-stick installation.
 Suitable for upgrading perimeter clearances up to *8.7mm.
 Cost savings for building owners as non-compliant fire door assemblies may be simply salvaged rather than replaced.
 Ideal for use in fire engineering solutions to limit the spread of hot gases around the edges of doors.
 Incorporates anti-microbial additives as standard.

■ Approvals

Fire: Tested in accordance with AS1530.4 on proprietary AS1905.1 fire door assemblies for up to 4 hour rating.

■ Standard lengths

1m, 2.1m and 2.75m.

Single doorset pack: (1 x 1m, 2 x 2.1m)

Long single doorset pack: (1 x 1m, 2 x 2.75m)

Double doorset pack: (3 x 2.1m)

Long double doorset pack: (1 x 2.1m, 2 x 2.75m)

■ Fixing method

Aggressive film backed self-adhesive.

■ Gap sizes

2mm - 8.7mm. *Please refer to our technical brochure "Retro-fit Sealing Solutions for Non-compliant Fire Door Assemblies" regarding maximum allowable gap sizes.*

■ Finish

Standard colour: White.



LVH Fire Rated Air Transfer Grilles



■ Description

Heavy duty intumescent air transfer grille designed for use in fire door assemblies where air transfer or additional ventilation is required.

■ Key benefits

Allows free airflow at ambient conditions. When exposed to fire or elevated temperatures the intumescent slats swell to create a physical barrier that provides up to 240 minutes resistance.

■ Approvals

Fire tested in accordance with AS1530.4 and approved for use on major AS1905.1 proprietary fire door types for up to 4 hours fire resistance.

■ Standard sizes

300mm x 300mm

450mm x 450mm

600mm x 300mm

600mm x 600mm

Supplied as complete kits including two steel cover grilles, fixings and a tube of Lorient intumescent sealant.

■ Fixing method

Perimeter caulked with Lorient intumescent sealant and sandwiched between the supplied steel cover grilles.

Please note: Suitable for interior use; if used in an external application, a suitable weather coating should be applied.

Vist www.lorient.com.au for approved fire door types and installation details.

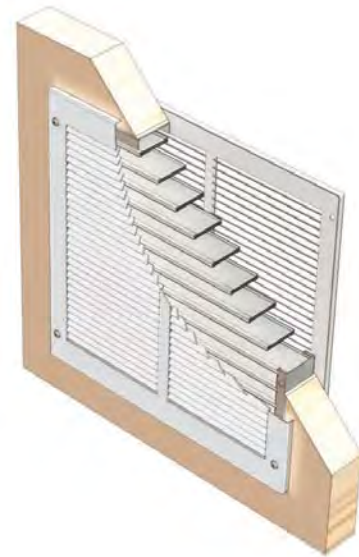

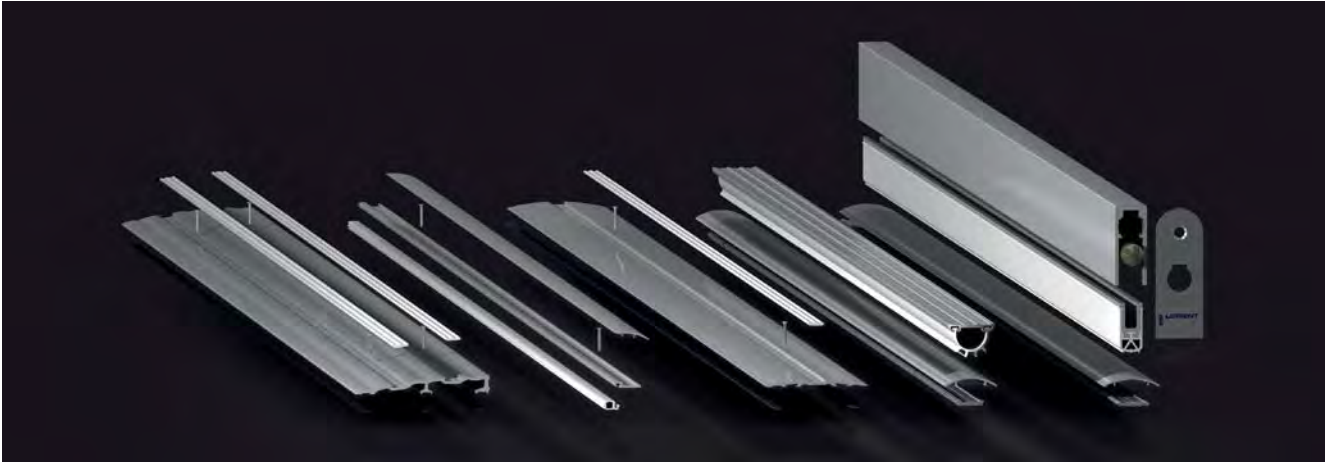







The AURA® range embraces a discerning selection of drop seals, perimeter seals, door bottom seals, threshold plates and ramps - all with strong design accents.

Every detail of the AURA® product range is considered and designed to integrate more successfully into beautifully designed doorsets and floors. A number of signature design details feature within the AURA® range; including a distinctive curved profile, which not only creates a sophisticated visual aesthetic, but also spreads and diffuses sound.

AURA® threshold plates and ramps incorporate hardwearing tread strips which deliver greater grip under foot. The unique reversible design provides either a smooth or ridged surface, depending on practical and aesthetic preferences. Wherever possible, AURA® fixings are completely concealed, enhancing the overall finish, preserving clean lines and curves, while also improving security and safety.

All products are manufactured to Lorient's exacting standards. AURA® perimeter seals and drop seals have been successfully tested for acoustic and smoke containment.

-  Acoustic protection
-  Smoke protection
-  Weather protection
-  Dust protection
-  Draught protection
-  Light protection
-  Wheelchair friendly

4551

THRESHOLD RAMP

For use in buildings where wheelchairs and trolleys are used, or to compensate for uneven floors. Reversible tread strips provide greater traction. Unique ‘scoops’ further enhance grip for foot or wheeled traffic.



TECHNICAL

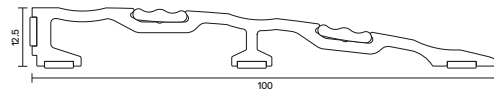

AAS4551

Location

Single and double swing doors

Seal Material

Aluminium with two flexible tread strips

Standard Lengths

- 1m and 2.1m
- Other lengths available for special order

Fixing

- Pre-drilled and countersunk
- Fixing screws supplied
- Tread strips supplied and push-fit into plate to conceal fixings

Finishes

- Silver anodised aluminium with Silver tread strips
- Decorative finishes for threshold plate and different colour tread strips available on request

AAS4551 ↓



PERFORMANCE

Fire

Approved for use on proprietary AS1905.1 fire doors for up to 4 hours.

4552

THRESHOLD RAMP

For use in buildings where wheelchairs and trolleys are used, or to compensate for uneven floors. Reversible tread strips provide greater traction. Unique 'scoops' further enhance grip for foot or wheeled traffic.



TECHNICAL

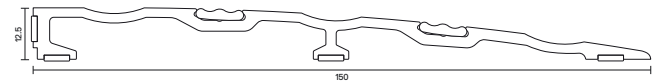

AAS4552

Location

Single and double swing doors

Seal Material

Aluminium with two flexible tread strips

Standard Lengths

- 1m and 2.1m
- Other lengths available for special order

Fixing

- Pre-drilled and countersunk
- Fixing screws supplied
- Tread strips supplied and push-fit into plate to conceal fixings

Finishes

- Silver anodised aluminium with Silver tread strips
- Decorative finishes for threshold plate and different colour tread strips available on request

AAS4552 ↓



PERFORMANCE

Fire

Approved for use on proprietary AS1905.1 fire doors for up to 4 hours.

4553

THRESHOLD RAMP

For use where wheelchairs and trolleys are used or to compensate for uneven floors. Reversible tread strips offer greater friction underfoot. Unique ‘scoops’ further enhance grip for foot or wheeled traffic.



AAS4553 ↓



TECHNICAL

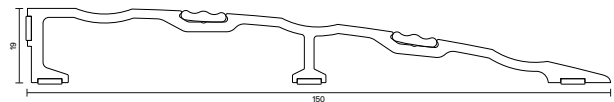

AAS4553

Location

Single and double swing doors

Seal Material

Aluminium with two flexible tread strips

Standard Lengths

- 1m and 2.1m
- Other lengths available for special order

Fixing

- Pre-drilled and countersunk
- Fixing screws supplied
- Tread strips supplied and push-fit into plate to conceal fixings

Finishes

- Silver anodised aluminium with Silver tread strips
- Decorative finishes for threshold plate and different colour tread strips available on request

PERFORMANCE

Fire

Approved for use on proprietary AS1905.1 fire doors for up to 4 hours.

7501

PERIMETER SEAL

Designed with a seamless curve for enhanced aesthetics, with proven performance for acoustic containment when installed around the head and jambs of doors. The decorative snap-on cover plate completely conceals fixings and is available in a range of finishes.

MEDIUM DUTY



TECHNICAL

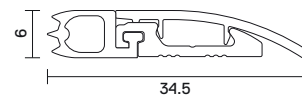

AAS7501

Location

Head and jambs of single swing doors

Seal Material

Silicone rubber

Standard Lengths

- 1m and 2.1m
- Doorset packs
 - Single doorset pack (SDP): (1 x 1m, 2 x 2.1m)
 - Long single doorset pack (LSDP): (1 x 1m, 2 x 2.7m)
 - Double doorset pack (DDP): (3 x 2.1m)
 - Long double doorset pack

(LDDP): (1 x 2.1m , 2 x 2.75m).

- Other lengths available for special order Fixing

Fixing

Fixing holes pre-drilled and slotted for positional accuracy.
Screw pack supplied.

Finishes

Silver anodised aluminium with grey silicone gasket.

AAS7501



PERFORMANCE

Fire

Approved for use on proprietary AS1905.1 fire doors for up to 4 hour fire rating

Acoustic

ISO 10140-2 & AS/NZS ISO717.1

Weighted Sound

Reduction Index

39 dB
(AAS7501 & AAS8501 on a proprietary acoustic door)

Durability

1,000,000 cycles on full-size door assemblies

7503

PERIMETER SEAL

A stylish perimeter seal with square cover plate ideal for butt-jointing or mitring. Proven performance for acoustic containment. The decorative cover plate completely conceals fixings.

MEDIUM DUTY



TECHNICAL

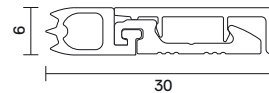

AAS7503

Location

Head and jambs of single swing doors

(LDDP):

(1 x 2.1m , 2 x 2.75m).

- Other lengths available for special order

Seal Material

Silicone rubber

Fixing

- Fixing holes pre-drilled and slotted for positional accuracy
- Screw pack supplied

Standard Lengths

- 1m and 2.1m
- Doorset packs
- Single doorset pack (SDP): (1 x 1m, 2 x 2.1m)
- Long single doorset pack (LSDP): (1 x 1m, 2 x 2.75m)
- Double doorset pack (DDP): (3 x 2.1m)
- Long double doorset pack

Finishes

- Silver anodised aluminium with grey silicone gasket
- Decorative finishes available. Please enquire

AAS7503

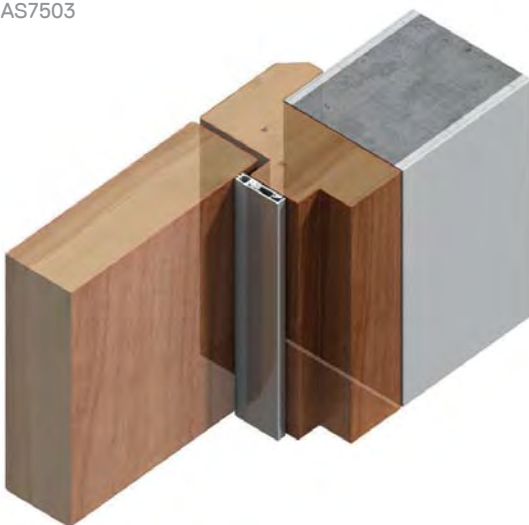

PERFORMANCE

Fire

Approved for use on proprietary AS1905.1 fire doors for up to 4 hour fire rating

Weighted Sound Reduction Index

39 dB
(AAS7503 & AAS8501 on a proprietary acoustic door)

Acoustic

ISO 10140-2 & AS/NZS ISO717.1

Durability

1,000,000 cycles on full-size door assemblies

7506

PERIMETER SEAL

A robust seal designed for use on plain or rebated meeting stiles. With proven acoustic performance it is also suitable for smoke, light, and draught containment. The leg can be cut out to make way for locks and latches.

MEDIUM DUTY



AAS7506



TECHNICAL

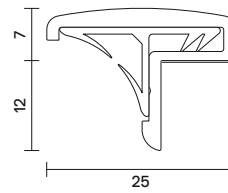

AAS7506

Location

Meeting stiles of single action double leaf doors - where only one door leaf is in use

Seal Material

Co-extruded elastomeric with flexible curved fins

Standard Lengths

- 2.25m and 2.75m

Fixing

- Fixing holes pre-drilled and countersunk
- Screw pack provided
- Using self-adhesive tape to position aluminium carrier while fixing, push-fit Batwing® seal into place

Note: A door selector should be considered unless one leaf is intended to be fixed

Finishes

- Silver anodised aluminium with grey gasket
- Other colours available

PERFORMANCE

Acoustic

ISO 10140-2 & AS/NZS ISO717.1

Weighted Sound Reduction Index

39 dB

(AAS7506 & AAS8501 on a proprietary acoustic door)

Smoke Leakage

BCA Specification C3.4 smoke sealing requirements

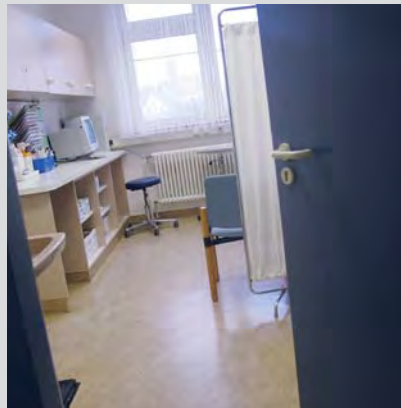

Fitting Instructions

Comprehensive fitting instructions are included with each consignment; and are also available to download from our website www.lorient.com.au

Maintenance

Periodic inspection and cleaning is recommended for all types of seals. The appearance and performance of seals will benefit from a wipe with a damp cloth. Seals should be checked for correct adjustment. Worn or damaged seals should be replaced immediately.

Compatibility

All Lorient Architectural Seals are compatible with the materials normally used in doors and door frames, including wood, steel, PVC, aluminium and glass.

Please Note: Recommendations as to methods, use of materials and construction details are based on the experience and knowledge of Lorient and are given in good faith as a general guide and a service to designers, contractors and manufacturers.

We continue to lead the way in research and development. As a company we have almost 40 years' experience, so our experts are well equipped to listen, help and advise you on your acoustic, smoke and fire containment needs.

testing & technical services

Technical Support

We're happy to provide specialist advice on acoustic, smoke and fire protection for refurbishment and new build projects. If you need assistance, you can call our Technical Services team.

Alternatively, we can arrange a site visit to get a clearer idea of your needs and how we can help you. We also provide copies of test reports and samples where needed and can give guidance on how best to meet Building Regulations and Standards.

Customisation

If you have a particular requirement which isn't covered by the applications in this brochure, we may be able to supply an existing non-standard item, or even develop a customised solution for you.

Testing Services

Our Testing & Technical Services centre offers a variety of specialist testing services including a state-of-the-art Acoustic Transmission Suite for manufacturers and designers of assemblies including doorsets, windows, glazing systems, door hardware to name but a few.

Whether you're investigating new materials, or developing new or existing products, right through to durability testing and benchmarking performance – our team of experts will support you throughout the process. If you're looking to work in partnership on a longer-term project, we'd be pleased to discuss your requirements.

Call our Technical Services team on
+61 (02) 9907 6221
www.lorient.com.au



Acoustic Transmission Suite

Our acoustic transmission suite is run by respected and experienced technical consultants, who will oversee the testing process from start to finish; and guide you through the maze of regulations. Working closely together, we'll design and implement a test programme to meet your specific requirements.

Our technicians have many years' experience building test specimens, and we also offer an installation service. Once the testing programme is complete, a number of options is available on top of an inclusive report, you could upgrade to a comprehensive report underwritten by an independent acoustic expert.

Indicative Furnace

Lorient's indicative furnace has proven popular for many years, providing customers with real insight into their own products' performance. Prior to full scale testing our customers can use the furnace for product development purposes – helping to save substantial testing costs.

Using our indicative furnace, the fire resistance properties of building materials can be tested in accordance with BS 476 Pt.20 or AS1530.4 (method of test for determination of the fire resistance of elements of construction) or be client specific to suit a particular purpose.

The test specimen (which only represents the top of the door) is placed at the front of the furnace and exposed to standard fire conditions. The location and period of fire resistance is determined by the regulatory requirement which could be 30/60/90 or 120 minutes.

Other testing services

Alongside full-scale acoustic testing and indicative fire testing, we also offer a range of complementary services. These include:

- Smoke leakage;
- Air leakage;
- Mechanical cycling;
- Environmental chamber analysis;
- Site-based acoustic testing;
- Attendance at external fire tests;
- Consultancy services.

For further information about Lorient products please visit our website

www.lorient.com.au

or follow us at:



@LorientAU



/company/lorient



Australia

Tel: +61 (02) 9907 6221

email: sales@lorientau.com.au



Purchase Lorient products through Access Hardware to earn 1 Qantas Point per \$1 spent for your business.
Find out more by calling Access Hardware customer service on 1800 555 600 or visit accesshardware.com.au*

**A business must be a Qantas Business Rewards member to earn Qantas points for business. Membership and Qantas Points are subject to Qantas Business Rewards Terms and Conditions at qantasbusinessrewards.com/terms and Access Hardware Terms and Conditions at www.accesshardware.com.au/qbr*

Customer Service
1800 555 600

Locksmithing
1800 555 700