

Panic Exit Devices

ED22 Series, ED2227 Series, ED22M Series, Accessories and Parts

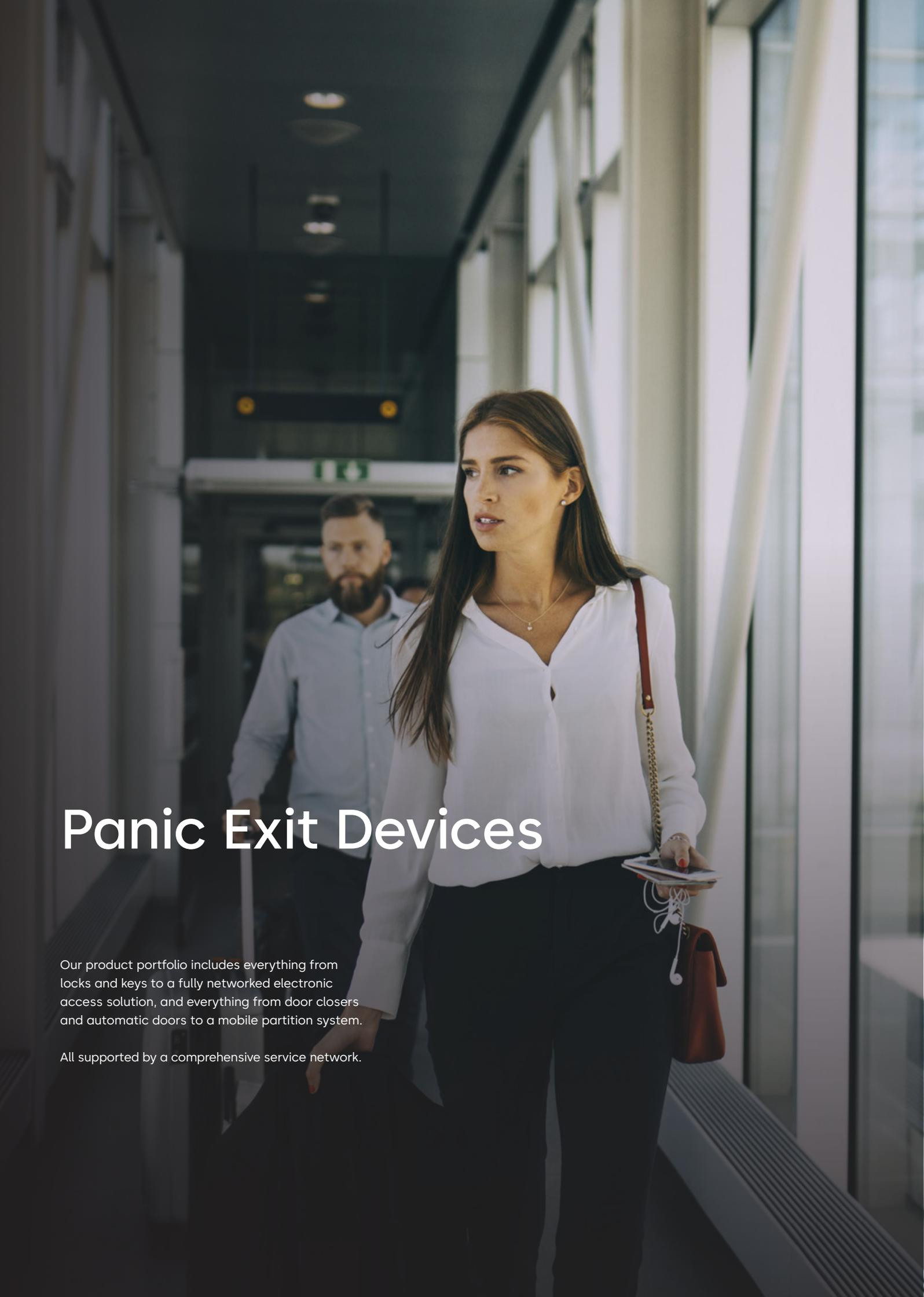



Panic Exit Devices

Our product portfolio includes everything from locks and keys to a fully networked electronic access solution, and everything from door closers and automatic doors to a mobile partition system.

All supported by a comprehensive service network.

Table of contents

4	Panic Hardware
5	Handing
6	Usage Chart
7-8	Dimensions
9	ED22 Rim
10	Functions and ordering details
11	ED22M Rim with Mortice Lock
12	Functions and ordering details
13	ED2227 Vertical Rod
14	Functions and ordering details
15	ED22/ED2227 Double Packs
16	Functions and ordering details
17	Accessories
18	External Trims
18	Extension Rods

Single action, push type emergency exit





Panic exit devices provide a fast and convenient means of escape in the case of an emergency

The dormakaba panic exit devices are available in rim exit and vertical rod devices for single doors as well as vertical rod devices for double doors.

Our panic exit devices have been designed to provide single action, push type emergency egress from buildings. We offer fire rated models across all panic exit device categories and our exit devices are suitable for use on doors constructed of either timber or metal.

Recommended Applications

- Retail complexes
- Commercial complexes
- Entertainment centres
- Hospitals
- Education Facilities
- Hotels

Handing of door

Right - hand door

Left - hand door

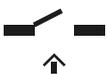

01

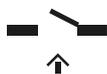

01

01

Outside door opening IN



02

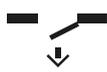

02

02

Outside door opening OUT

Fire Rating



The dormakaba panic exit devices without the dogging (latch hold back) function have been successfully tested on fire door assemblies to comply with Australian Standard AS1905 Part 1, Fire Resistant door sets.

All testing is carried out by independent laboratories. When specifying/ordering add suffix "F" to code, eg. ED22MFSSS.

ED22 and ED2227 series will be listed as no dogging for fire rated versions.

Note: Fire doors cannot include dogging due to fire regulations

Usage Chart

Flush and Fire doors

Rebate or overlapping astragal

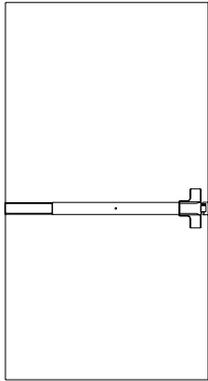

ED22/ED22M

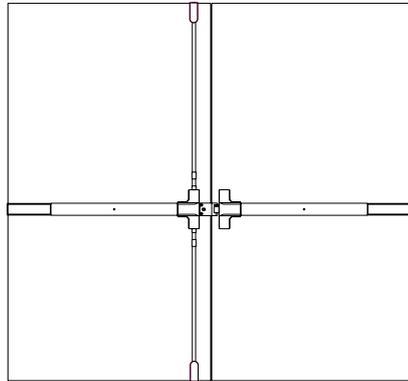

ED2227

ED22

or
ED22DP
Door co-ordinator recommended

Timber Glazed or Aluminium Doors

Rebate or overlapping astragal

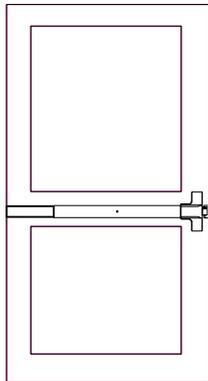

ED22/ED22M

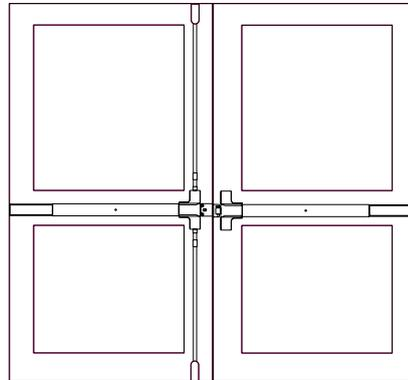

ED2227

ED22

or
Timber glazed doors - surface
mounted ED22DP
Aluminium doors - edge mounted
ED22DP plus ED1942B strike
refer accessories and parts

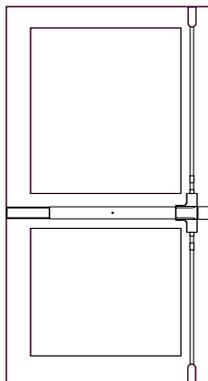

ED22/ED22M

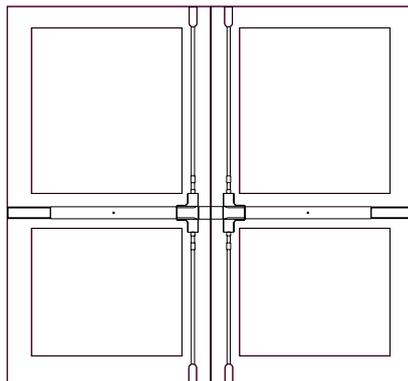

ED2227

ED2227

Note:
On both timber and glazed
aluminium doors a 105mm minimum
stile plus rebate or
bead stop is required.

A mid rail is required for doors over
1050mm between door stops or
when using external trims.

Dimensions

ED22 Series - Rim type

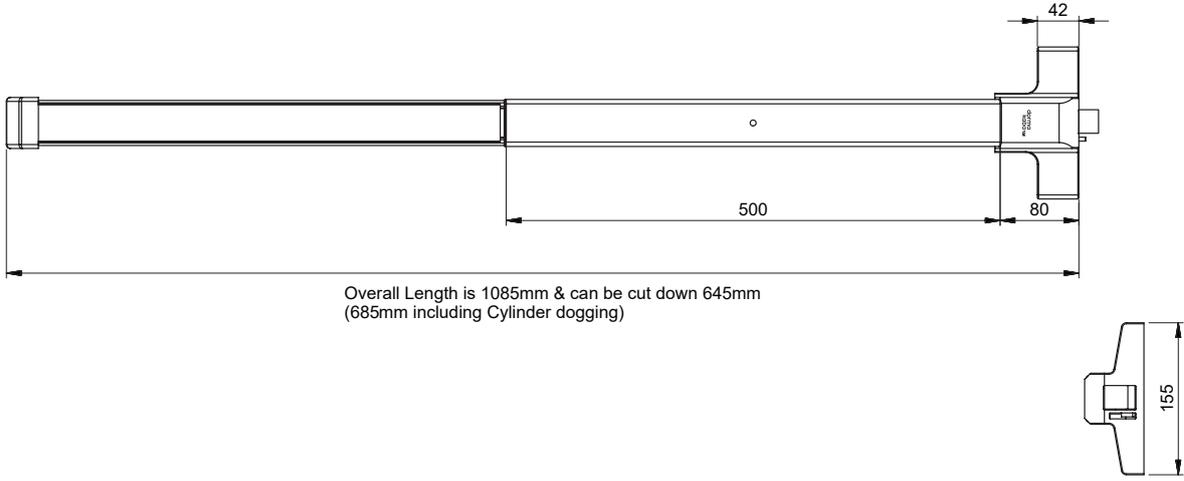

ED22M Series - Motice type

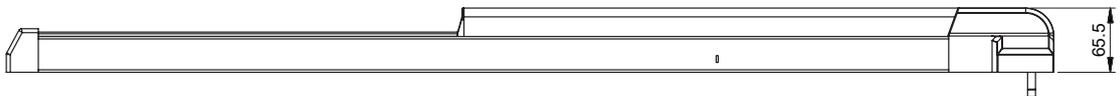
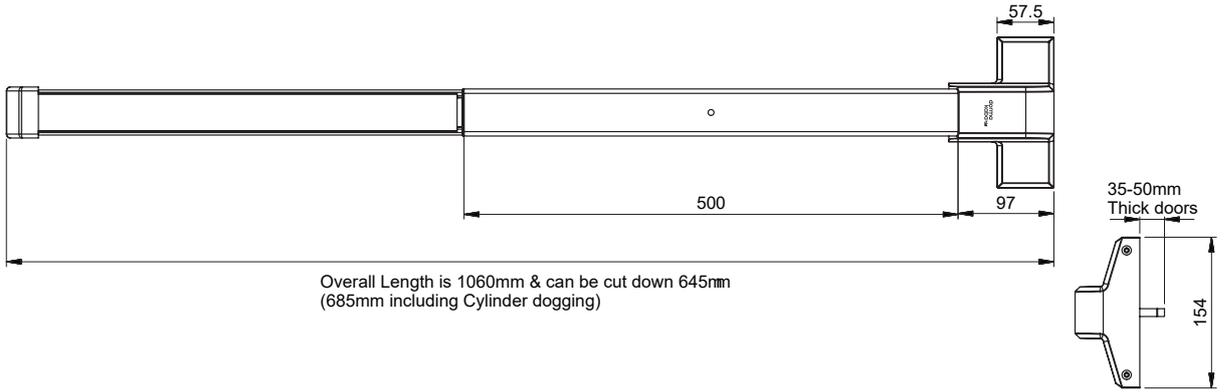

Dimensions

ED2227 Series - Vertical rod type

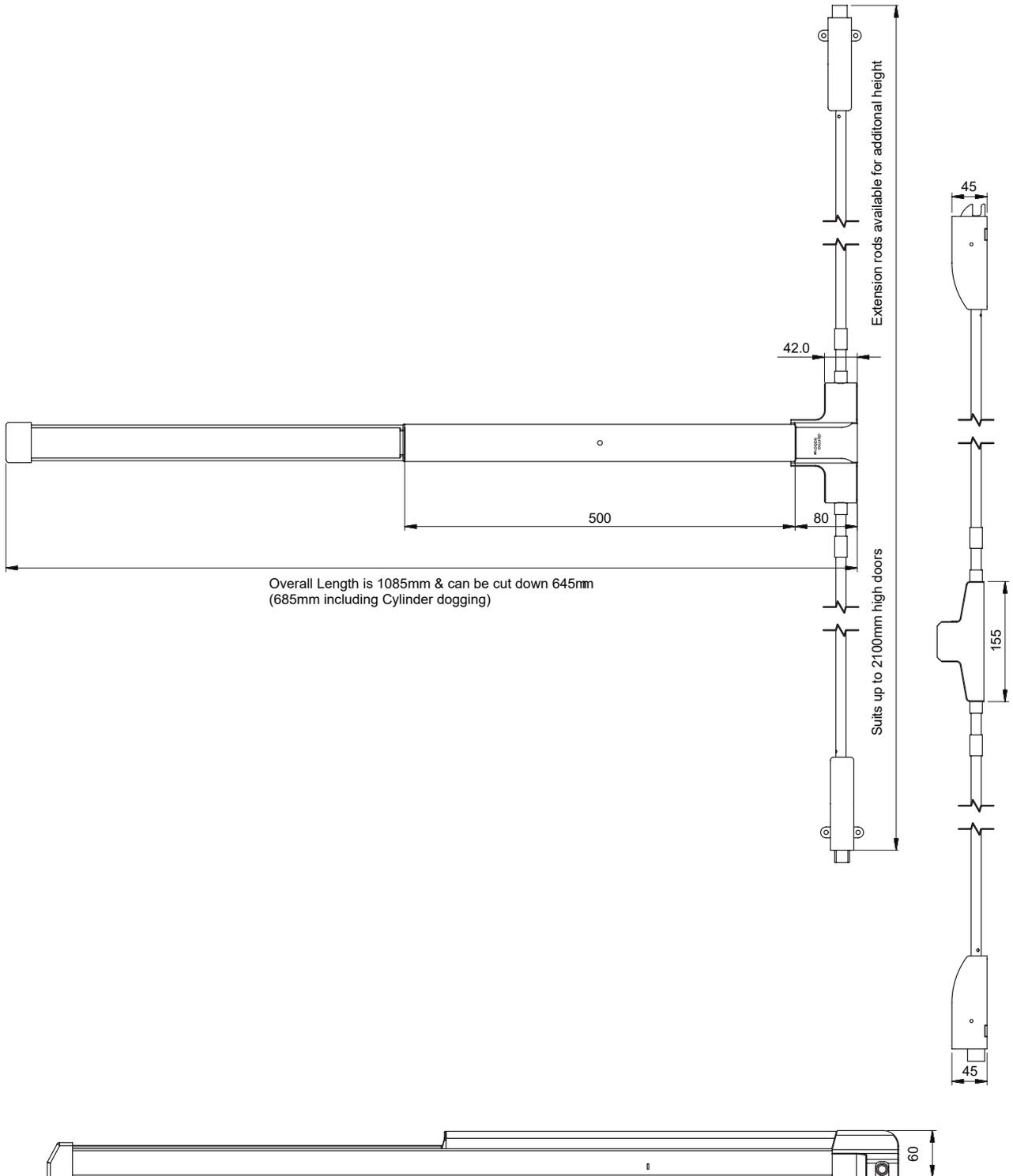



Images are for illustrative purposes only.

ED22 Series - Rim

Exit Device

The dormakaba ED22 Series Rim type panic exit device is designed to provide emergency egress by a single action pushing motion via a modern design touch pad, fitted horizontally across the door.

The ED22 provides secure dead latching function and offers latch hold back (dogging) options, external trim options for lever/knob or pull handle and is suitable for double or single, metal or timber doors.

Length

Supplied in 1085mm standard length. Can be field sized to 645mm minimum length (including strike). Cylinder dogging (CD) adds 40mm to minimum length.

Stile

105mm minimum stile plus rebate or bead stop. A mid rail is required for glazed aluminium/timber doors over 1050mm between door stops or when using external trims.

Fixings

Timber self-tapping screws and metal machines screws supplied as standard.

Construction

Pressed and cast metal casing. Operating parts made of steel and brass. Main and auxiliary latch bolt constructed of stainless steel

Handing

Non handed

Finish

Silver (painted) and Satin Stainless Steel (SSS)

Dogging

Hex (Allen) key type supplied as standard. Optional cylinder dogging available – when specifying/ordering use suffix "CD" (Factory fitted).

Note: Fire doors cannot include dogging due to fire regulations.

Fire Rating



The dormakaba ED22 has been successfully tested on fire door assemblies in accordance with Australian Standard AS 1905 Part 1: Fire resistant door sets. When specifying/ordering add suffix "F" to code, eg. ED22E0FSIL.

Note: Fire doors cannot include dogging due to fire regulations

External trim

121 Cylinder for Nightlatch (NL) function or Key in knob/Key in lever for classroom function. Through fixing Pull handle on plate available as pull only or D pull with round hole to suit rim cylinder.

Note: DP pull with round hole is handed - available as accessories.

Optional External Trims

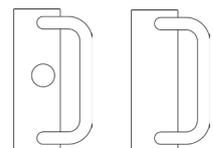

Function	Cylinder	Knob	Lever	Pull Handle
Nightlatch	121	N/A		
Classroom		EDK70	EDL70	
No function				ED22PH
Nightlatch				ED22PHNL

Specifications

Suffix	Inside Action	Outside Action
EO	Exit Only	Nil
NL	Exit Only	Key entry

For Square Edge Stile Aluminium Doors only - order EDP1942B in addition to the exit device.
For external trims and accessories refer to the Exit Device Accessories and Parts page.

Item	Article Number	Description	Barcode
HEX KEY DOGGING - RIM DEVICES			
ED22EOSIL	9400000002208	ED22EO EXIT ONLY 1085MM SIL Contents: ED22, EDP01-05SSS	9322844077668
ED22EOSSS	9400000002209	ED22EO EXIT ONLY 1085MM SSS Contents: ED22, EDP01-05SSS	9322844084185
ED22NLSIL	9400000002216	ED22NL NIGHT LATCH SIL Contents: ED22, 121 Cylinder, EDP01-05SSS	9322844017824
ED22NLSSS	9400000002217	ED22NL NIGHT LATCH SSS Contents: ED22, 121 Cylinder, EDP01-05SSS	9322844022453
NO DOGGING - RIM DEVICES - FIRE RATED			
			
ED22EOFIL	9400000002206	ED22EOF EXIT ONLY FIRE RATED 1085MM SIL Contents: ED22, EDP01-05SSS	9322844024471
ED22EOFSSS	9400000002207	ED22EOF EXIT ONLY FIRE RATED 1085MM SSS Contents: ED22, EDP01-05SSS	9322844128513
ED22NLFIL	9400000002214	ED22NLF NIGHT LATCH FIRE RATE 1085MM SIL Contents: ED22, 121 Cylinder, EDP01-05SSS	9322844025348
ED22NLFSSS	9400000002215	ED22NLF NIGHT LATCH FIRE RATE 1085MM SSS Contents: ED22, 121 Cylinder, EDP01-05SSS	9322844208765
CYLINDER DOGGING - RIM DEVICES			
ED22EOCDIL	9400000002204	ED22EOCD EXIT ONLY 1085MM SIL Contents: ED22, 140 Cylinder, EDP01-05SSS	9322844070607
ED22NLCDSSS	9400000002213	ED22NLCD NIGHT LATCH 1085MM SSS Contents: ED22, 121 Cylinder, 140 Cylinder, EDP01-05SSS	9322844195157



Images are for illustrative purposes only.

ED22M Series - Rim with Mortice Lock

Exit Device

The dormakaba ED22M has been designed to operate in conjunction with the renowned MS2 mortice lock.

The ED22M offers all the security functions of the MS2602 mortice lock whilst providing a fast and convenient means of escape in the case of an emergency. The exit device is supplied with convenient mounting plates, providing fast, secure and easy thru fixing to timber doors.

The ED22M is supplied complete with ED22 exit device and MS2602ED (modified for double doors) mortice lock.

Length

Supplied in 1060mm standard length.
Can be field sized to 645mm minimum length.

Stile

115mm to suit metal/aluminium where mounting plates are not used. A mid rail is required if mounting plates are fitted or if the door opening is greater than 1050mm.

Mounting

Timber - Mounting plates and thru fixing screws (supplied).
Metal/Aluminium - Fixing direct to metal surface less mount plates (fixings not included).
Drill and tap recommended.

Fixings

Supplied as standard with fixings for surface and thru fixing (surface fixings supplied as self-tapping timber screws).

Construction

Pressed and cast metal casing. Operating parts made of steel and brass. Main and auxiliary latch bolt constructed of stainless steel

Handing

Reversible

Finish

Satin Stainless Steel (SSS)

Dogging

Hex (allen) key type supplied as standard. Cylinder dogging by external hold back cylinder.

Fire Rating



A fire rated version of the ED22M (ED22MF) is available. This version comes without the dogging function. The ED22MF has been successfully tested on fire door assemblies in accordance with Australian Standard AS1905 Part 1: Fire door sets. When specifying/ordering add suffix "F" to code, eg. ED22MFSSS

Note: Fire doors cannot include dogging due to fire regulations

Specifications

OPTIONAL EXTERNAL TRIMS

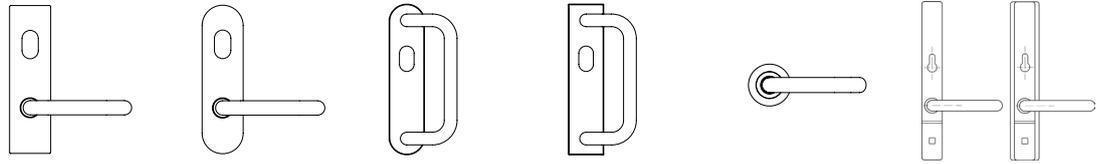

Function	6600 Series	6700 Series	6780	6680	4000 Series	c-lever
Nightlatch	6610	6710			4306	Refer to c-lever options
Storeroom	6600F	6700F	6780 L or R	6680 L or R	4306 & 4400	
Classroom	6600	6700			4306 & 4400	

The ED22M is supplied complete with ED22 exit device and MS2602ED (modified for double doors) mortice lock. For external trims and accessories refer to accessories and parts page 17.

Item	Article Number	Description	Barcode
HEX KEY DOGGING - RIM WITH MORTICE DEVICE			
ED22MSSS	9400000002211	ED22M EXIT DEVICE MORTICE HEXDOGG SSS Contents: ED22MLESSLPSSS, MS2602EDSSS, ED22M-MPSSS	9322844046671
NO DOGGING - RIM WITH MORTICE DEVICE FIRE RATED			
ED22MFSSS	9400000002210	 ED22MF EXIT ONLY MORTICE LOCK FIRE RATED SSS Contents: ED22MLESSLPSSS, MS2602EDSSS, ED22M-MPSSS	9322844047494

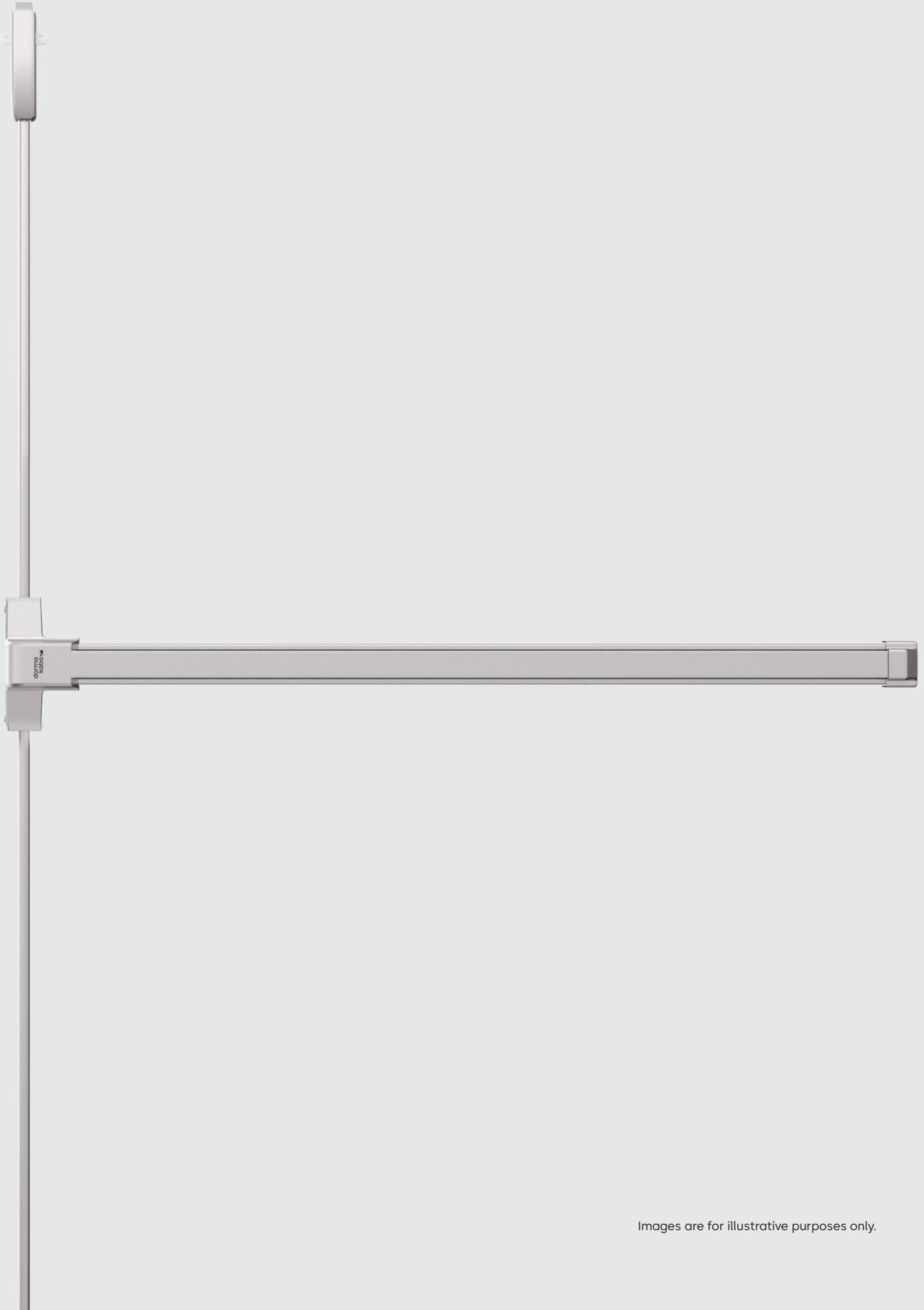

Images are for illustrative purposes only.

ED2227 Series - Vertical Rod

Exit Device

The dormakaba ED2227 series vertical rod type panic exit device is designed to provide emergency egress by a single action pushing motion via a modern design touch pad, fitted horizontally across the door.

The ED2227 provides secure two point latching in top and bottom of door and offers latch hold back (dogging) options, external trim options for lever/knob and is suitable for double or single, metal or timber doors.

Length

Supplied in 1085mm standard length. Can be field sized to 645mm minimum length (including strike). Cylinder dogging (CD) adds 40mm to minimum length.

Stile

105mm minimum stile plus rebate or bead stop. A mid rail is required for glazed aluminium/timber doors over 1050mm between door stops or when using external trims.

Fixings

Timber self-tapping screws and metal machines screws supplied as standard.

Construction

Pressed and cast metal casing. Operating parts made of steel and brass. Stainless steel latchbolts.

Handing

Reversible

Finish

Satin Stainless Steel SSS

Silver (painted) SIL

Dogging

Hex (allen) key type supplied as standard. Optional cylinder dogging available – when specifying/ordering use suffix "CD" (factory fitted).

Fire Rating



The ED2227 series has been successfully tested on fire door assemblies in accordance with Australian Standard AS 1905 Part 1: Fire resistant door sets. When specifying/ordering add suffix "F" to code, eg. ED2227EOFSIL.

Note: Fire doors cannot include dogging due to fire regulations

External trim

121 cylinder for nightlatch (NL) function or key in knob/key in lever for classroom function.

Height

Suits 2100mm high doors.

Extension rods available in 600mm lengths.

Optional External Trims



Function	Cylinder	Knob	Lever
Nightlatch	121		
Classroom		EDK70	EDL70
No function			

Specifications

Suffix	Inside action	Outside action
EO	Exit only	Nil
NL	Exit only	Key entry

For Square Edge Stile Aluminium Doors only - order ED1942B in addition to the exit device.

For external trims and accessories refer to the Exit Device Accessories and Parts page.

Item	Article Number	Description	Barcode
HEX KEY DOGGING - VERTICAL DEVICES			
ED2227EOSIL	9400000002184	ED2227EO EXIT ONLY 1085MM SIL Contents: ED2227, EDP04-95SSS, EDP11, EDP1609-95SSS	9322844046725
ED2227EOSSS	9400000002185	ED2227EO EXIT ONLY 1085MM SSS Contents: ED2227, EDP04-95SSS, EDP11, EDP1609-95SSS	9322844052542
ED2227NLSIL	9400000002190	ED2227NL NIGHT LATCH 1085MM SIL Contents: ED2227, 121 Cylinder, EDP04-95SSS, EDP11, EDP1609-95SSS	9322844224659
ED2227NLSSS	9400000002191	ED2227NL NIGHT LATCH 1085MM SSS Contents: ED2227, 121 Cylinder, EDP04-95SSS, EDP11, EDP1609-95SSS	9322844025317
NO DOGGING - VERTICAL DEVICES - FIRE RATED			
			
ED2227EOF SIL	9400000002182	ED2227EOF EXIT ONLY FIRE RATED 1085MM SIL Contents: ED2227, EDP04-95SSS, EDP11, EDP1609-95SSS	9322844140898
ED2227EOFSSS	9400000002183	ED2227EOF EXIT ONLY FIRE RATED 1085MM SSS Contents: ED2227, EDP04-95SSS, EDP11, EDP1609-95SSS	9322844025331
ED2227NLF SIL	9400000002188	ED2227NLF NIGHT LATCH FIRE RATE 1085MM SIL Contents: ED2227, 121 Cylinder, EDP04-95SSS, EDP11, EDP1609-95SSS	9322844219228
ED2227NLFSSS	9400000002189	ED2227NLF NIGHT LATCH FIRE RATE 1085MM SSS Contents: ED2227, 121 Cylinder, EDP04-95SSS, EDP11, EDP1609-95SSS	9322844045575
CYLINDER DOGGING - VERTICAL DEVICES			
ED2227EOCDSIL	9400000002180	ED2227EOCD EXIT ONLY CYL DOG 1085MM SIL Contents: ED2227, 140 Cylinder, EDP04-95SSS, EDP11, EDP1609-95SSS	9322844155137
ED2227EOCDSSS	9400000002181	ED2227EOCD EXIT ONLY CYL DOG 1085MM SSS Contents: ED2227, 140 Cylinder, EDP04-95SSS, EDP11, EDP1609-95SSS	9322844161312
ED2227NLCDSIL	9400000002186	ED2227NLCD NIGHT LATCH C/DOG 1085MM SIL Contents: ED2227, 121 Cylinder, 140 Cylinder, EDP04-95SSS, EDP11, EDP1609-95SSS	9322844214308
ED2227NLCDSSS	9400000002187	ED2227NLCD NIGHT LATCH C/DOG 1085MM SSS Contents: ED2227, 121 Cylinder, 140 Cylinder, EDP04-95SSS, EDP11, EDP1609-95SSS	9322844219259

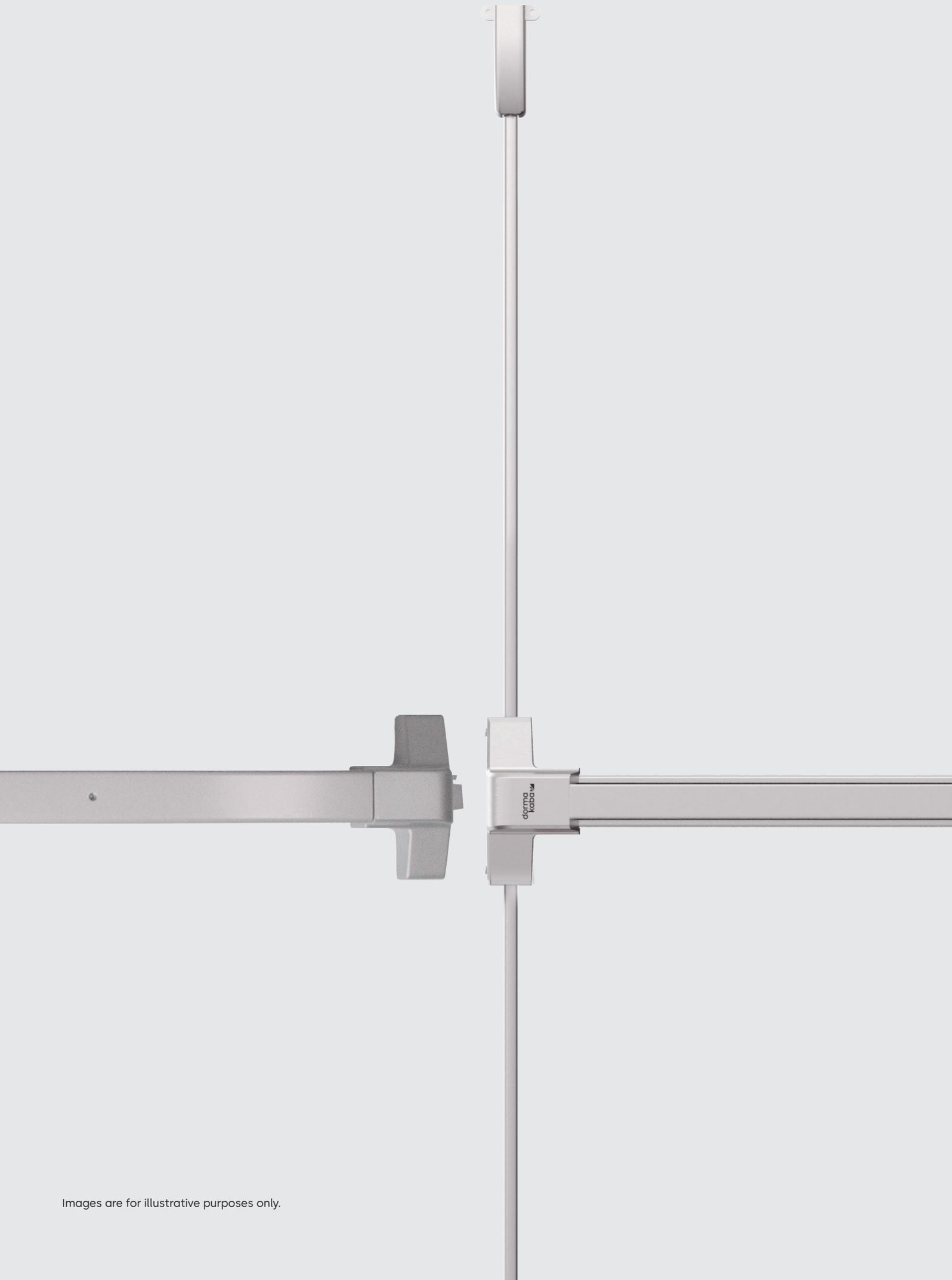

Images are for illustrative purposes only.

ED22/ ED2227 Series Double Packs

Exit Device

ED22DP series double pack panic exit devices are designed to provide emergency egress by a single action pushing motion via a modern design touch pad, fitted horizontally across the doors.

The ED22DP provides secure locking in double door applications and offers latch hold back (dogging) options, external trim options for lever/knob and is suitable for double or single, metal or timber doors.

Specifications

Suffix	Inside action	Outside action
EO	Exit only	Nil
NL	Exit only	Key entry

For square edge stile aluminium doors only - order ED1942B in addition to the exit device.
For external trims and accessories refer to the exit device accessories and parts page.

Item	Article Number	Description	Barcode
HEX KEY DOGGING - DOUBLE PACKS			
ED22DPEOSIL	940000002196	ED22DPEO DBL PCK EXIT ONLY 1085MM SIL Contents: ED22, ED2227, EDP01-05SSS, EDP1609-95SSS	9322844127493
ED22DPEOSSS	940000002197	ED22DPEO DBL PCK EXIT ONLY 1085MM SSS Contents: ED22, ED2227, EDP01-05SSS, EDP1609-95SSS	9322844133449
ED22DPNLSIL	940000002202	ED22DPNL DBL PCK N/LATCH 1085MM SIL Contents: ED22, ED2227, 121 Cylinder, EDP01-05SSS, EDP1609-95SSS	9322844069038
ED22DPNLSSS	940000002203	ED22DPNL DBL PCK N/LATCH 1085MM SSS Contents: ED22, ED2227, 121 Cylinder, EDP01-05SSS, EDP1609-95SSS	9322844037808
NO DOGGING - DOUBLE PACKS- FIRE RATED			
			
ED22DPEOSIL	940000002194	ED22DPEOF DBL PCK EXIT ONLY 1085MM SIL Contents: ED22, ED2227, EDP01-05SSS, EDP1609-95SSS	9322844087070
ED22DPEOFSSS	940000002195	ED22DPEOF DBL PCK EXIT ONLY 1085MM SSS Contents: ED22, ED2227, EDP01-05SSS, PS1609-95SSS	9322844092715
ED22DPNLSIL	940000002200	ED22DPNLF DBL PCK N/LATCH 1085MM SIL Contents: ED22, ED2227, 121 Cylinder, EDP01-05SSS, EDP1609-95SSS	9322844064439
ED22DPNLFSSS	940000002201	ED22DPNLF DBL PCK N/LATCH 1085MM SSS Contents: ED22, ED2227, 121 Cylinder, EDP01-05SSS, EDP1609-95SSS	9322844051293
CYLINDER DOGGING - DOUBLE PACKS			
ED22DPEOCD SIL	940000002192	ED22DPEOCD DBL PCK EXIT ONLY 1085MM SIL Contents: ED22, ED2227, 140 Cylinder, EDP01-05SSS, EDP1609-95SSS	9322844229937
ED22DPEOCDSSS	940000002193	ED2227EOCD EXIT ONLY CYL DOG 1085MM SSS Contents: ED22, ED2227, 140 Cylinder, EDP01-05SSS, EDP1609-95SSS	9322844025195
ED22DPNLCDSIL	940000002198	ED2227NLCD NIGHT LATCH C/DOG 1085MM SIL Contents: ED22, ED2227, 121 Cylinder, 140 Cylinder, EDP01-05SSS, EDP1609-95SSS	9322844100984
ED22DPNLCDSSS	940000002199	ED2227NLCD NIGHT LATCH C/DOG 1085MM SSS Contents: ED22, ED2227, 121 Cylinder, 140 Cylinder, EDP01-05SSS, EDP1609-95SSS	9322844104395

Accessories and Parts

	Item	Article Number	Description	Barcode
ACCESSORIES				
	MS2602EDSSS	9400000006899	MS2602ED EXIT LOCK FOR ED22M SSS	9322844089364
	ED22M-MPSSSS	94000000 12133	ED22M MOUNT PLATE SET & SCREWS SSS	
	ED22M-SPSSS	94000000 12132	ED22M SCREW PACK ONLY SSS	
	ED22MLESSLPSS	94000000 12050	ED22M EXIT DEVICE LESS LOCK & PLATES SSS	
	EDP01-05SSS	9400000002223	ED22 STD STRIKE & SHIM	9322844304016
	EDP04-95SSS	9400000002224	ED2227 TOP VERTICAL ROD STRIKE	9322844019293
	EDP11	9400000002225	ED2227 BRASS FLOOR SOCKET	9322844047982
	EDP1609-95	9400000002226	ED22DP STRIKE AND WEAR PLATE SSS	9322844305839
	EDP1942B	9400000002227	ED22 EDGE MOUNTED STRIKE SSS	9322844019231
	EDP901	9400000002228	EDP902 ED VERT ROD LATCH COV SIL	9322844019354
	EDP902	9400000002229	EDP902 ED VERT ROD GUIDE - STEEL	9322844019156
	EDP904	9400000002230	EDP904 ED VERT ROD CONNECTING PIN	9322844306430
	EDP905	9400000002231	EDP905 ED END CAP & BRACKET - NYLON	9322844037266
	EDP905SSS	9400000005472	EDP905 ED END CAP & BRACKET - SSS	
	EDP907	9400000002232	EDP907 ED VERTICAL ROD TOP 890MM	9322844064729
	EDP908	9400000002233	EDP908 ED VERTICAL ROD BOTTOM 840MM	9322844064743
	EDP920	9400000002234	EDP920 ED LATCH MECH & COVER TOP	9322844303545
	EDP921	9400000002235	EDP921 ED LATCH MECH & COVER BOTTOM	9322844304924
	EDP922	9400000002236	EDP922 DOGGING KEY	9322844019149
	EDP925	9400000002237	EDP925 ED GUIDE SLEEVE SUIT EDP902 NYLON	9322844019163
	EDP926	9400000002238	EDP926 SLIDE COVER	9322844019361

Accessories and Parts

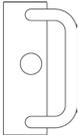
	Item	Article Number	Description	Barcode
EXTERNAL TRIMS				
	EDK70SSS	9400000002221	EDK70 KNOB - CLASSROOM FUNCTION SSS	9322844305525
	EDL70SCP	9400000002222	EDL70 LEVER - CLASSROOM FUNCTION SCP	9322844300582
	ED22PHSSS	9400000002220	ED22PH PULL HANDLE AND PLATE SSS	9322844024600
	ED22PHNLSSSL	9400000002218	ED22PHNL P/HANDLE & PLATE N/L LH SSS	9322844189408
	ED22PHNLSSSR	9400000002219	ED22PHNL P/HANDLE & PLATE N/L RH SSS	9322844189798

Note:

For external 6600, 6700 plate furniture, 4000 series lever handles and c lever options please refer to relevant brochures.

EXTENSION ROD				
	ED22/44ERSIL	9400000002178	ED22/44ER EXTENSION ROD 600MM SIL	9322844303620
	ED22/44ERSSS	9400000002179	ED22/44ER EXTENSION ROD 600MM SSS	9322844303293
	ED22/44EROSIL	9400000002176	ED22/44ERO ED EXT ROD 1700MM SIL	9322844305396
	ED22/44EROSSS	9400000002177	ED22/44ERO ED EXT ROD 1700MM SSS	9322844303743



Door
Hardware



Electronic
Access & Data



Mechanical
Key Systems



Lodging
Systems



Entrance
Systems



Interior Glass
Systems



Safe
Locks



Service

Our Sustainability Commitment

We are committed to fostering a sustainable development along our entire value chain in line with our economic, environmental and social responsibilities toward current and future generations.

We seek an open, transparent dialogue with all stakeholders to define strategies and actions based on clear targets and continuous improvement, and we actively report on our progress.

dormakaba Australia
Head Office
12-13 Dansu Court
Hallam VIC 3803

T: 1800 675 411
info.au@dormakaba.com
dormakaba.com.au

dormakaba New Zealand
Head Office
Building P, 61-69 Patiki Road
Avondale, Auckland 1026

T: 0800 436 762
info.nz@dormakaba.com
dormakaba.co.nz