



Sabre Lever on 65mm Rose S06 - Satin Stainless Steel

SKU SAB-LS-R65-S06-SSS

MPN SAB-LS-R65-S06-SSS



DESCRIPTION

Sabre Passage Lever on 65mm Rose S06 Satin Stainless Steel

Made from 304 Grade Stainless Steel
Quality investment cast rose
Solid investment cast lever
Non handed (site adjustable)
Suitable for door thickness between 34mm and 50mm
Made from durable and low maintenance stainless steel
Tested for durability for up to 500,000 cycles
Concealed threaded rose cover
AS1428-1 compliant

SPECIFICATION

MPN	SAB-LS-R65-S06-SSS
Brand	Sabre
Product Length	144mm
Projection or Length	52mm
Rose Diameter	65mm
Product Finish or Colour	Satin Stainless Steel (SSS)
Product Material	304 Stainless Steel
Includes Fixing Screws	Yes
AS1428.1 Compliant	Yes
Fire Tested	Yes
SCEC Rating	No
Handing	Non-Handed
Fixing	Concealed Fixed
Spindle Size	7.6mm
Finger Clearance	43mm
Max Door Thickness	50mm
Product Warranty	10 Years Mechanical

ADDITIONAL IMAGES



Sabre Lever on 65mm Rose S06 - Satin Stainless Steel

Scan to view online and for additional product information , or call us on **1800 555 600**.

Print Date: 28/4/24

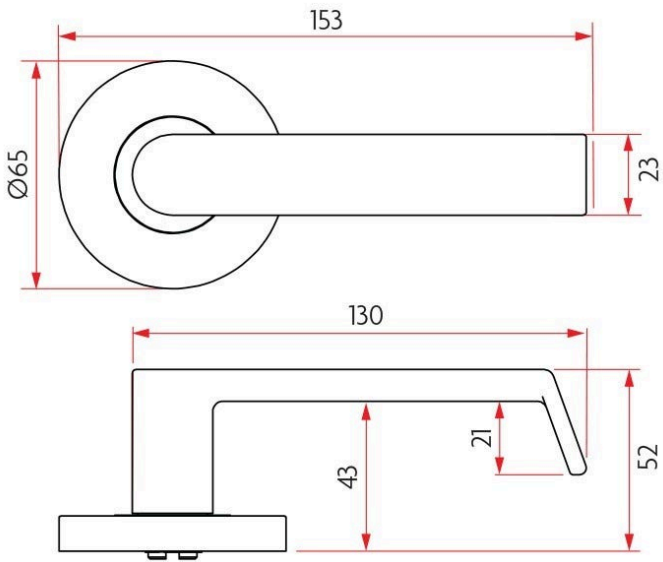

Sabre Lever on 65mm Rose S06 - Satin Stainless Steel

Scan to view online and for additional product information , or call us on **1800 555 600**.

Print Date: 28/4/24